

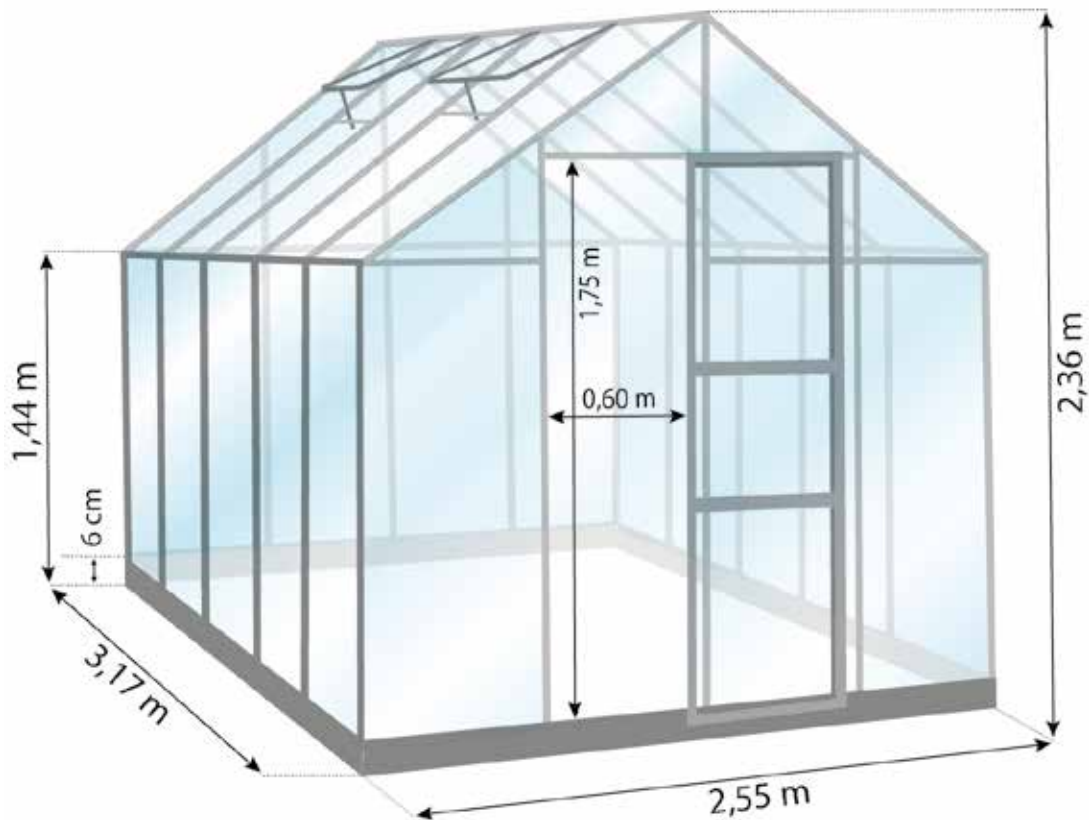

# LAMS



**SERRE - GEWÄCHSHAUS - GREENHOUSE**

**CARVI 8,10 M<sup>2</sup>**



# NOTICE DE MONTAGE

## IMPORTANT

- Merci de lire ces instructions attentivement avant de commencer le montage de la serre.
- Merci de vous assurer que toutes les pièces mentionnées sur cette notice sont présentes dans le carton et de vérifier les quantités.
- Merci de suivre les étapes dans l'ordre indiqué par la notice.
- Veuillez conserver soigneusement ce manuel de montage pour une consultation ultérieure.

## CONSEILS DE SÉCURITÉ

- Veuillez porter gants, chaussures et lunettes de protection pour le montage de la serre.
- Respectez les conseils de sécurité des outils que vous utilisez pour ce montage.
- En cas d'intempéries (pluie, vent, orage...), ne montez pas votre serre.
- La serre doit être montée par 2 personnes.
- Les sachets plastiques et les petits composants sont à tenir hors de portée des enfants. Eloignez les enfants de la zone de montage.
- L'aluminium est un métal conducteur d'électricité, tenez les profilés aluminium éloignés de toute source électrique.
- Tout appareil produisant de la chaleur ne doit pas être stocké dans la serre (barbecue, chalumeau, ...).
- La serre doit être positionnée et fixée sur un sol horizontal et plan, non exposé au vent.
- Vérifiez l'absence de réseaux (eau, électricité, gaz) sous l'emplacement de montage de la serre.
- Attention, ne pas monter sur le toit : risque de chute et de blessures graves.
- En cas de forte chute de neige ne pas laisser la neige s'accumuler sur le toit.

## CONSEILS D'ENTRETIEN

- Pour nettoyer votre serre, utilisez de l'eau claire savonneuse.
- N'utilisez surtout pas d'acétone, des nettoyants abrasifs ou autres détergents spéciaux pour nettoyer les panneaux.
- Graissez régulièrement le rail de porte.
- Dégagez le toit de la neige et des feuilles.



## SERVICE CLIENTS

Site internet : [www.sav-doviris.com](http://www.sav-doviris.com)



# MONTAGEANLEITUNG

## WICHTIG

- Bitte lesen Sie diese Anleitung sorgfältig durch, bevor Sie mit der Montage beginnen.
- Bitte stellen Sie sicher, dass alle in dieser Anleitung aufgeführten Einzelteile im Karton vorhanden sind und prüfen Sie die Mengen.
- Bitte folgen Sie den Schritten in der im Handbuch angegebenen Reihenfolge.
- Bewahren Sie diese Anleitung für späteres Nachschlagen sorgfältig auf.

## SICHERHEITSHINWEISE

- Bitte tragen Sie bei der Montage des Gewächshauses Handschuhe, Schuhe und Schutzbrille.
- Beachten Sie die Sicherheitshinweise der Werkzeuge, die Sie für diese Montage verwenden.
- Stellen Sie Ihr Gewächshaus nicht bei schlechtem Wetter (Regen, Wind, Gewitter . . .) auf.
- Das Gewächshaus muss von 2 Personen zusammengebaut werden.
- Die Plastiktüten und Kleinteile sollten außerhalb der Reichweite von Kindern aufbewahrt werden. Halten Sie die Kinder vom Montagebereich fern.
- Aluminium ist ein elektrisch leitfähiges Metall, halten Sie die Aluminiumprofile von allen elektrischen Quellen fern.
- Wärmezeugenden Geräte (Grill, Brenner, . . .) dürfen im Gewächshaus nicht gelagert werden.
- Das Gewächshaus muss auf einem horizontalen und ebenen, nicht dem Wind ausgesetzten Boden aufgestellt und befestigt werden.
- Stellen Sie sicher, dass es keine Netze (Wasser, Strom oder Gas) unter dem Installationsort gibt.
- Achtung, nicht auf das Dach steigen: Sturz- und schwere Verletzungsgefahr.
- Bei starkem Schneefall den Schnee nicht auf dem Dach ansammeln lassen.

## PFLEGEHINWEISE

- Verwenden Sie zur Reinigung Ihres Gewächshauses klares Seifenwasser.
- Verwenden Sie kein Aceton, Scheuermittel oder andere Reinigungsmittel zum Reinigen der Platten.
- Regelmäßig die Türschiene schmieren.
- Räumen Sie das Dach frei von Schnee und Laub.



## KUNDENSERVICE

[kontakt@gewaechshaus-lams.com](mailto:kontakt@gewaechshaus-lams.com)



# ASSEMBLY INSTRUCTIONS

## IMPORTANT

- Please read these instructions carefully before starting to assemble the greenhouse.
- Please ensure that all the components mentioned in this instruction are present in the box and check the quantities.
- Please follow the steps in the order indicated by the manual.
- Please keep this assembly instruction in a safe place for future reference.

## SAFETY WARNINGS

- Please wear gloves, shoes and safety goggles when assembling the greenhouse.
- Follow the safety instructions of the tools you use for this assembly.
- In case of bad weather (rain, wind, thunderstorm, ...), do not set up your greenhouse.
- The greenhouse must be assembled by 2 people.
- Plastic bags and small components should be kept out of reach of children. Keep children away from the assembling area.
- Aluminium is a metal with electrical conductivity, keep aluminium profiles away from any electrical source.
- Not all heat-producing appliances (barbecue, torch, ...) can be stored in the greenhouse.
- The greenhouse must be positioned and fixed on a horizontal and even ground, not exposed to wind.
- Check the absence of networks (water, electricity, gas) underneath the installation site of the greenhouse.
- Beware, do not climb on the roof : risk of fall and serious injuries.
- In case of heavy snowfall, do not allow snow to accumulate on the roof.

## MAINTENANCE TIPS

- To clean your greenhouse, use clear soapy water.
- Do not use acetone, abrasive cleaners or other special detergents to clean the panels.
- Grease the door rail regularly.
- Clear the roof of snow and leaves.



## CUSTOMER SERVICE

Website : [www.sav-doviris.com](http://www.sav-doviris.com)

**SERRE - GEWÄCHSHAUS - GREENHOUSE**  
**CARVI 8,10 M<sup>2</sup>**

**RÉFÉRENCES - ARTIKELNUMMERN - CODES :**

- **ALUMINIUM : 788695**
- **RAL 6009 : 788697**
- **RAL 7016 : 795139**











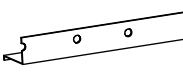
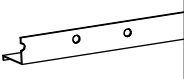
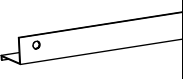





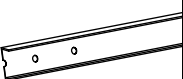
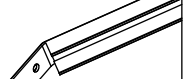

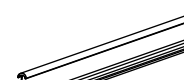







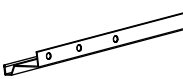
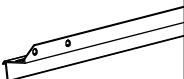
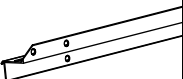



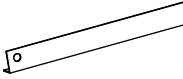
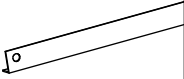
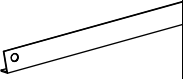



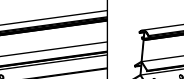
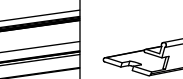
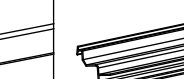

---

**NUMÉRO DE TRAÇABILITÉ - RÜCKVERFOLGBARKEITSNUMMER - TRACEABILITY NUMBER**  
**2021.10**





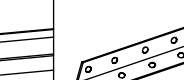
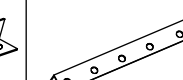
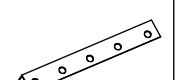
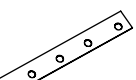
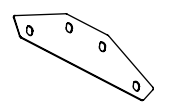
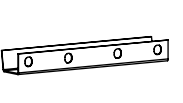
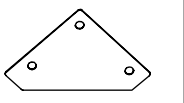
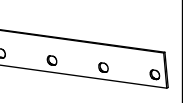
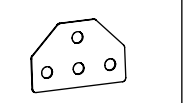
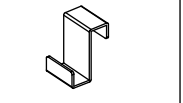

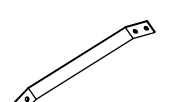
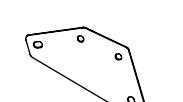
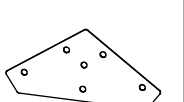
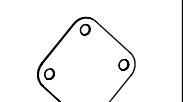
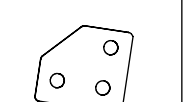
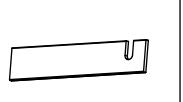



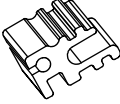
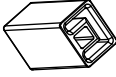
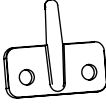
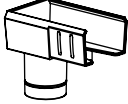

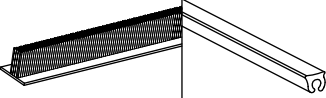
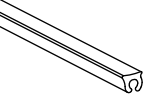
# NOMENCLATURE - STÜCKLISTE - BILL OF MATERIALS

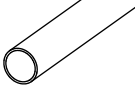
## Colis - Paket - Parcel

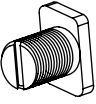









1/3 & 2/3

PROFILÉS ALUMINIUM - ALUMINIUMPROFILE - ALUMINIUM PROFILES							
01001 x 1  L:1241 mm	01002 x 1  L:1241 mm	01007 x 1  L:1862.5 mm	01008 x 1  L:1862.5 mm	01009 x 1  L:610 mm	01010 x 1  L:1874 mm	10001 x 1  L:1257 mm	
15001 x 2  L:270 mm	18001 x 1  L:612 mm	23001 x 1  L:1235.5 mm	23002 x 1  L:1235.5 mm	24001 x 4  L:1160 mm	25005 x 8  L:1511 mm	25009 x 2  L:422 mm	
25010 x 8  L:1350 mm	25011 x 2  L:1802 mm	25012 x 2  L:1802 mm	25013 x 2  L:1802 mm	27007 x 4  L:1350 mm	27008 x 2  L:1535 mm	27009 x 2  L:1535 mm	
30003 x 1  L:610 mm	30004 x 1  L:1874 mm	32003 x 1  L:1250 mm	32004 x 1  L:1250 mm	33003 x 1  L:619 mm	33004 x 1  L:619 mm	33008 x 4  L:1896 mm	
33010 x 4  L:1760 mm	33011 x 1  L:1241 mm	33012 x 1  L:1241 mm	33013 x 2  L:1413 mm	33014 x 2  L:1776 mm	34003 x 2  L:1760 mm	35001 x 1  L:621 mm	
36001 x 1  L:621 mm	37001 x 2  L:621 mm	38001 x 1  L:1241 mm	38003 x 1  L:1862.5 mm	39001 x 2  L:634 mm	40001 x 2  L:602 mm	41001 x 4  L:518 mm	58001 x 4  L:18 mm
42001 x 2  L:602 mm	43004 x 1  L:1241 mm	43005 x 1  L:1241 mm	43006 x 1  L:1862.5 mm	43007 x 1  L:1862.5 mm	45001 x 1  L:400 mm	46001 x 4  L:250 mm	46002 x 1  L:200 mm
PETITS COMPOSANTS - KLEINTEILE - SMALL COMPONENTS							
W001 x 4  L:1241 mm	W002 x 2  L:1241 mm	W003 x 15  L:1241 mm	W004 x 2  L:1241 mm	W005 x 3  L:1241 mm	W006 x 118  L:118 mm	W007 x 372  L:372 mm	
W012 x 8  L:1241 mm	W014 x 4  L:1241 mm	W015 x 2  L:1241 mm	W016 x 2  L:1241 mm	W020 x 2  L:1241 mm	W026 x 2  L:1241 mm		

# NOMENCLATURE - STÜCKLISTE - BILL OF MATERIALS

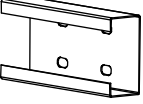
2001 x 2 	2002 x 2 	2004 x 2 	2005 x 4 	2022 x 2 	2023 x 2 	2010 x 2 
2019 x 2  L:1760 mm	2006 x 92 m 	2028 x 2 	2032 x 2 	2035 x 2  L:1260 mm	1001 x 285  M6	1002 x 267  M6 x 12 mm
1003 x 8  M6 x 8 mm	1004 x 16  M3.5 x 16 mm	1005 x 16  M3.5 x 6 mm	1011 x 8  M6 x 14 mm	1012 x 2  M6 x 5 mm	1015 x 4  Ø 6	









## BASE ET VISSERIE - FUNDAMENTRAHMEN UND SCHRAUBEN - GREENHOUSE BASE AND SCREWS

D007 x 4  1894 x 60 x 30 mm	D008 x 2  650 x 60 x 30 mm	D009 x 2  1272 x 60 x 30 mm	D011x 4 	D012 x 2 	D013 x 4 	D014 x 4 
1008 x 32 	1009 x 32  M6 x 12 mm	1010 x 32  M6	W008 x 22 			

## Colis - Paket - Parcel

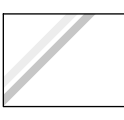
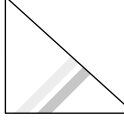
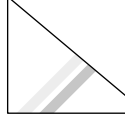
3/3

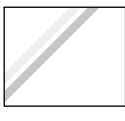
## VERRES - GLÄSER - GLAZING

1 x 2  610 x 610 mm	5 x 2  600 x 544 mm	8 x 51  610 x 456 mm	9 x 3  610 x 461 mm	10 x 1  610 x 378 mm	11 x 4  610 x 434/8 mm	12 x 4  610 x 468/40 mm
14 x 10  610 x 509 mm	15 x 10  610 x 487 mm	16 x 8  610 x 549 mm	<b>OUTILS INCLUS</b> <b>VORHANDENES WERKZEUG</b> <b>TOOLS INCLUDED</b>		<b>NON INCLUS</b> <b>NICHT VORHANDEN</b> <b>NOT INCLUDED</b>	

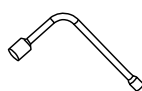

M6/10 mm

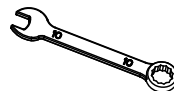

M6/10 mm

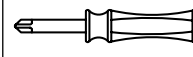

10 m

# MONTAGE BASE - MONTAGE FUNDAMENTRAHMEN - BASE ASSEMBLING

Il est impératif que la base soit montée de niveau.



Es ist zwingend erforderlich, dass der Fundamentrahmen auf einem Untergrund montiert wird.

It is imperative that the greenhouse base is leveled.

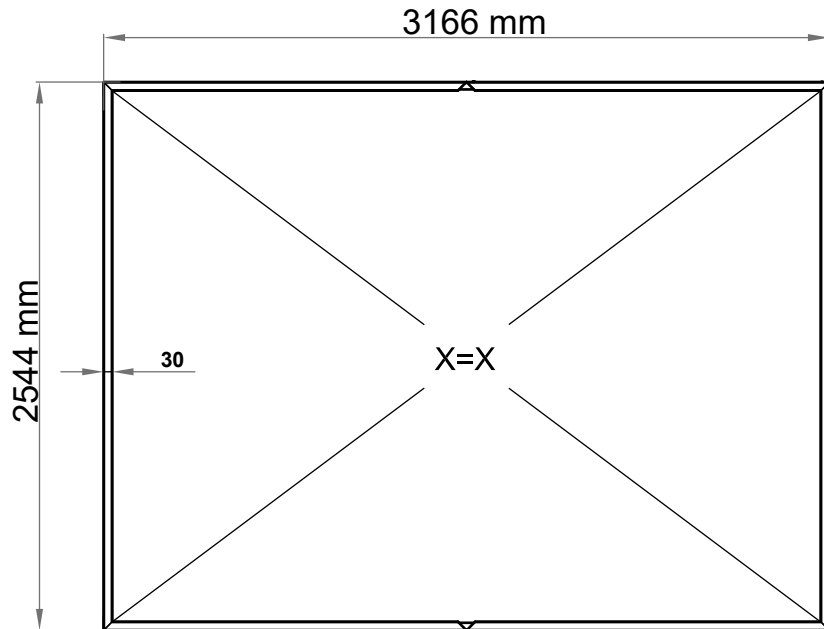

FACE AVANT (AVEC PORTE)  
VORDERWAND (MIT TÜR)  
FRONT WALL (WITH DOOR)



Plots béton / Punktfundament / Point foundation : D011 + D012 + D013.

Dalle ou pourtour béton / Streifenfundament / Concrete slab or frame : D013.

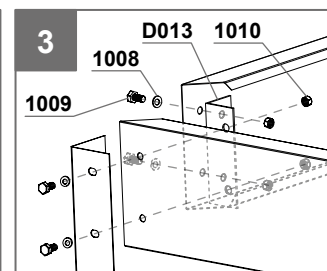
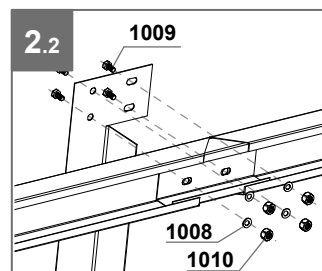
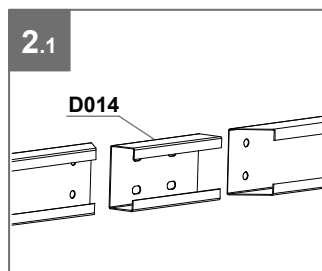
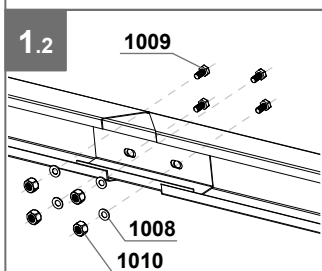
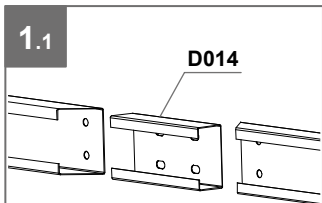
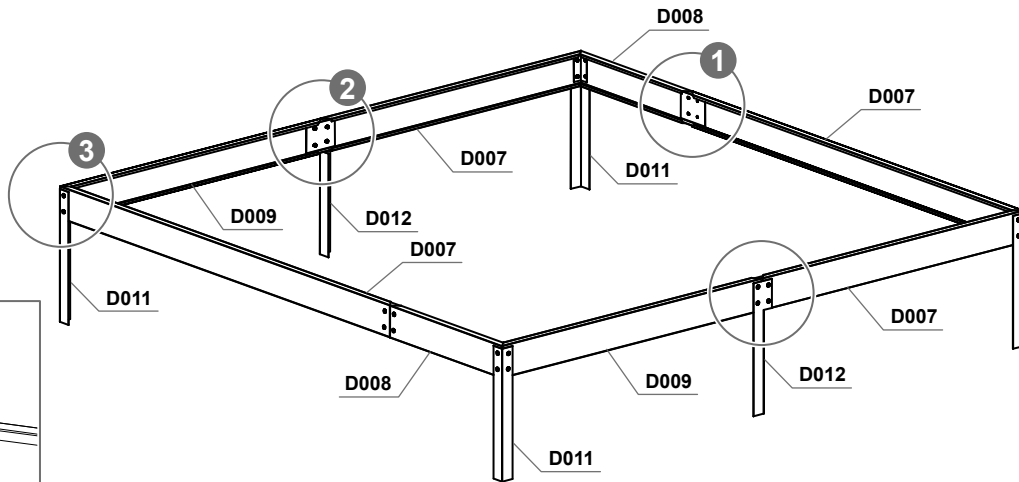

Module de base  
Basismodul  
Basic module

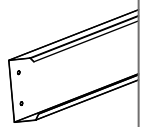

D007 x 4

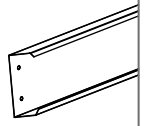

D008 x 2

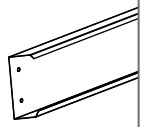

D009 x 2

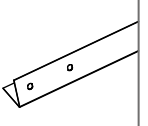

D011 x 4

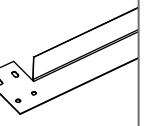

D012 x 2

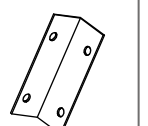

D013 x 4

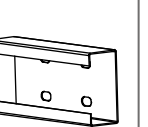

D014 x 4

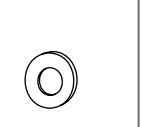

1008 x 32

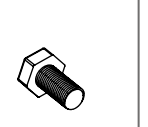

1009 x 32

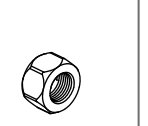

1010 x 32





# FIXATION DE LA BASE AU SOL

## FIXATION EN PLEINE TERRE

- Positionner la base à l'endroit voulu, de niveau sur un sol damé.
- Repérer l'emplacement des pattes de scellement suivant le schéma ci-dessous.
- Marquer un carré de 300 x 300 mm autour des pattes de scellement et creuser sur une profondeur de 450 mm.
- Placer la base, la mettre de niveau et remplir les trous de béton.

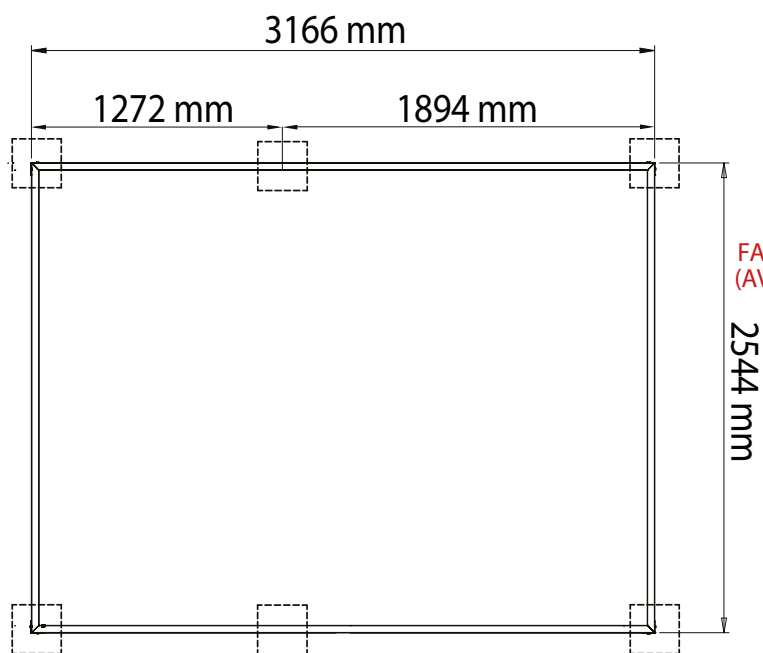

FACE AVANT  
(AVEC PORTE)

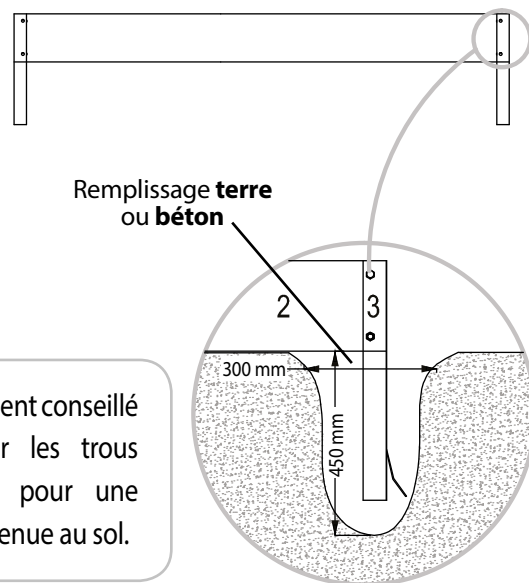

Il est vivement conseillé de remplir les trous de béton pour une meilleure tenue au sol.

OU

## FIXATION SUR DALLE BÉTON

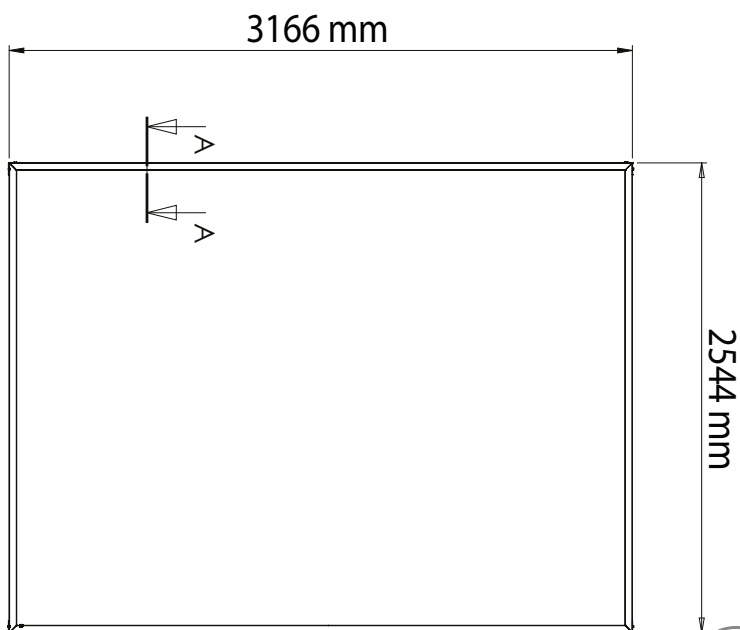

Détail A-A

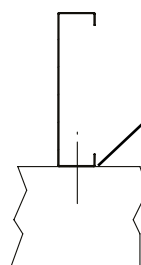

Fixation par chevilles à l'intérieur de la base



Visseries et chevilles de fixation non fournies

Il est laissé à votre libre choix et décision, l'utilisation des fixations adéquats selon les supports que vous décidez d'utiliser (pourtour bois, parpaings, plaques ciment, ...).



# BEFESTIGUNG DES FUNDAMENTRAHMENS AM BODEN

## BEFESTIGUNG AUF ERDBODEN (Punktfundament)

- Stellen Sie den Fundamentrahmen an der gewünschten Stelle, auf einem ebenen Boden.
- Finden Sie die Stelle der Ankerbeine gemäß dem untenstehenden Schema.
- Markieren Sie ein 300 x 300 mm Quadrat um die Ankerbeine herum und graben Sie 450 mm tief.
- Den Fundamentrahmen platzieren, nivellieren und die Löcher mit Beton füllen.

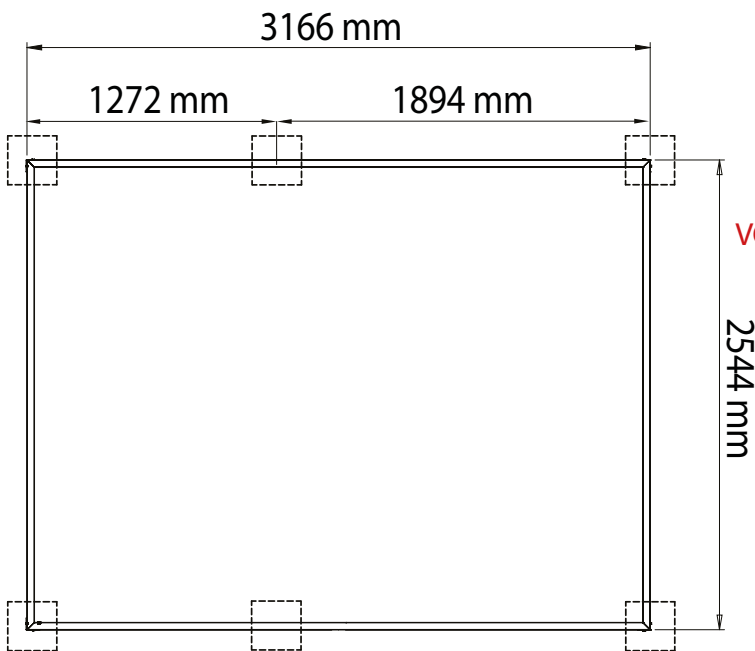

**VORDERWAND  
(MIT TÜR)**

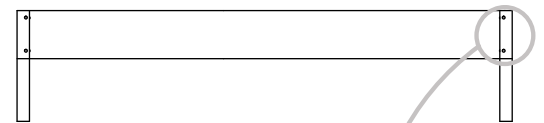

Erde oder Betonfüllung

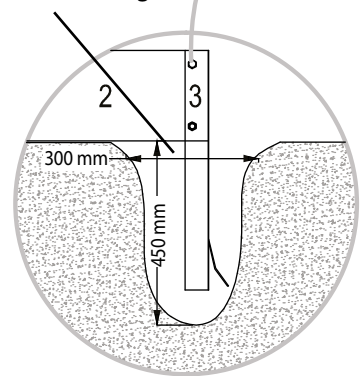

Es wird dringend empfohlen,  
die Löcher mit Beton zu füllen,  
um einen besseren Halt auf  
dem Boden zu gewährleisten.

**ODER**

## BEFESTIGUNG AUF BETONDECKE (Streifenfundament)

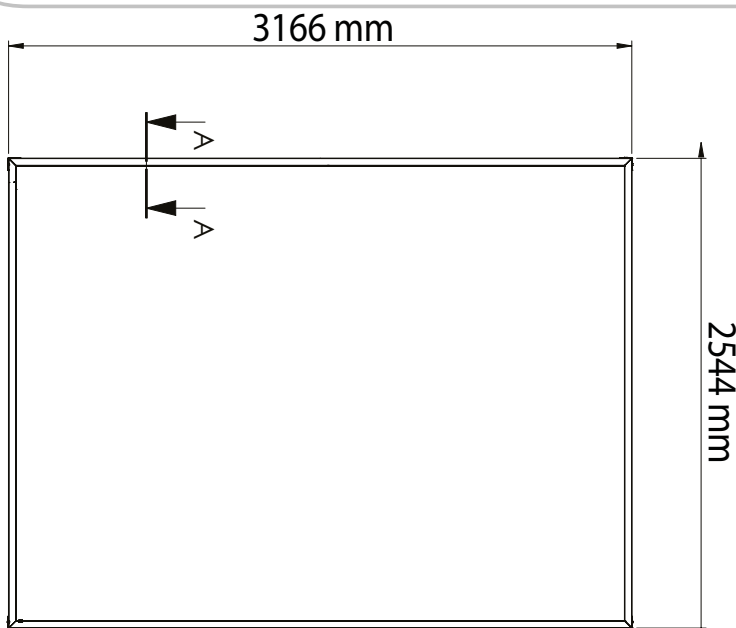

Detail A-A

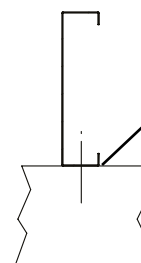

Dübelbefestigung im Inneren  
des Fundamentrahmens



**Schrauben und  
Befestigungsdübel  
nicht im Lieferumfang  
enthalten**

Es bleibt Ihrer freien Wahl und Entscheidung  
überlassen, die geeigneten Befestigungsmittel  
entsprechend der von Ihnen gewählten Träger  
(Holzumrandung, Bausteine, Zementplatten,...)  
zu verwenden.



# FIXING THE GREENHOUSE BASE TO THE GROUND

## FIXING ON SOIL (POINT FOUNDATION)

- Position the greenhouse base in the desired location at a level position.
- Locate the base legs as shown bellow.
- Mark a 300 x 300 mm square around the base legs and dig 450 mm deep.
- Place the greenhouse base, level it and fill the holes with concrete.

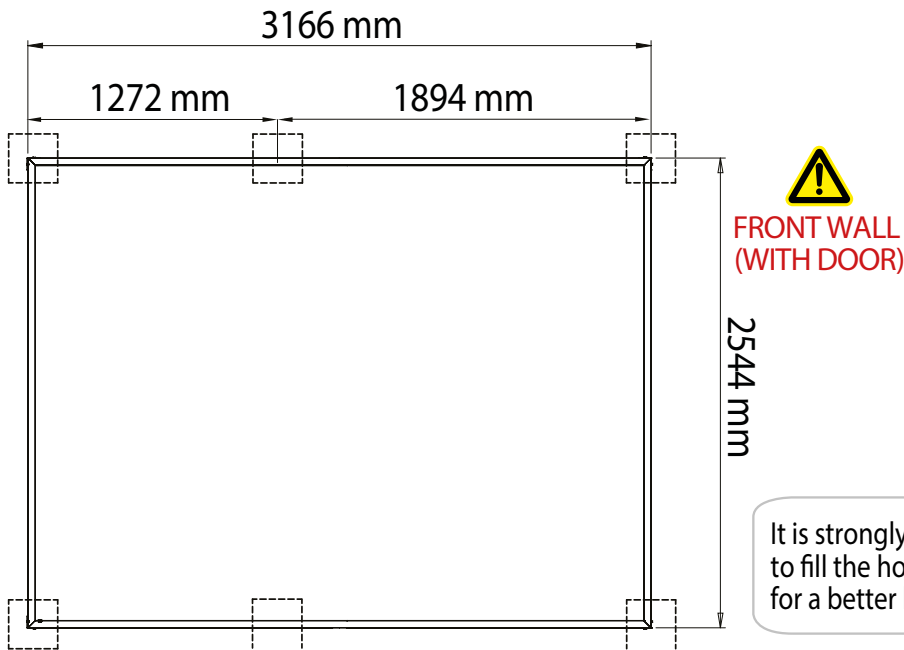

**FRONT WALL (WITH DOOR)**

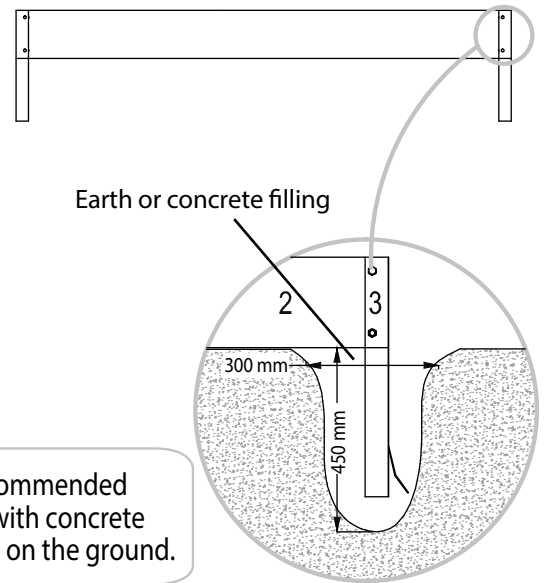

It is strongly recommended to fill the holes with concrete for a better hold on the ground.

**OR**

## FIXING ON CONCRETE SLAB

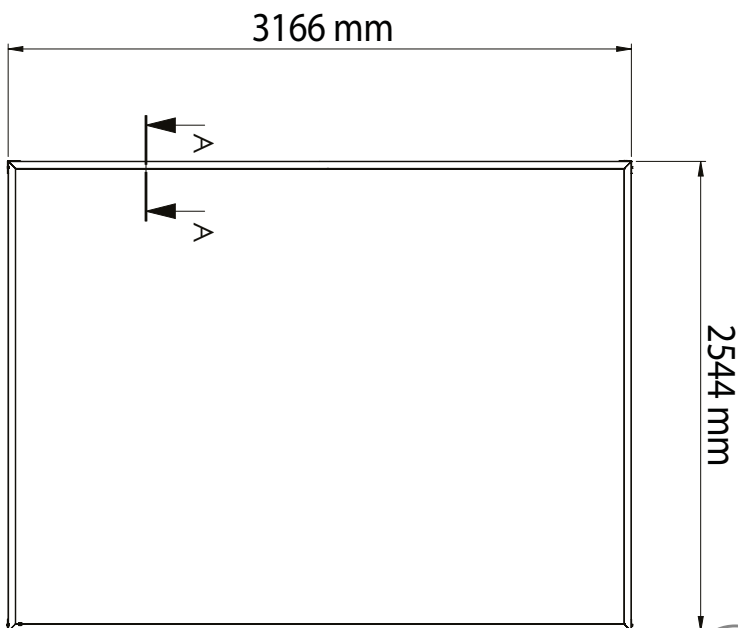

Detail A-A

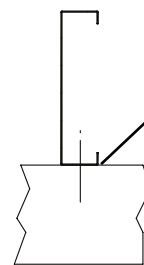

Rawplug fastening inside the greenhouse base



**Screws and rawplugs not provided**

It remains to your free choice and decision to use the suitable fastening means according to the supports you chose (wood border, building stones, cement plates etc.)

# VIS 1002 & 1003 - SCHRAUBEN 1002 & 1003 - SCREWS 1002 & 1003

Mise en place des vis 1002 et 1003 dans les rainures en forme de T des profilés aluminium :  
Entrez la tête de vis dans la rainure du profilé et tournez à 90° afin qu'elle ne puisse pas sortir du profilé. Assemblez la/les pièce(s) nécessaire(s) et serrez l'écrou.

Verwendung der Schrauben 1002 und 1003 in den t-förmigen Nuten der Aluminiumprofile :  
Schraubenkopf in die Profilmutter stecken und diesen um 90° drehen, damit er nicht aus dem Profil herauskommt. Bauen Sie das/die benötigte(n) Einzelteil(e) zusammen und ziehen Sie die Schraubenmuttern an.

Principle of use of screws 1002 and 1003 in the T-shaped grooves of the aluminium profiles :  
Enter the screw head into the groove of the profile and turn the screw head at 90° so that it cannot exit the profile. Assemble the required part(s) and tighten the screw nut.

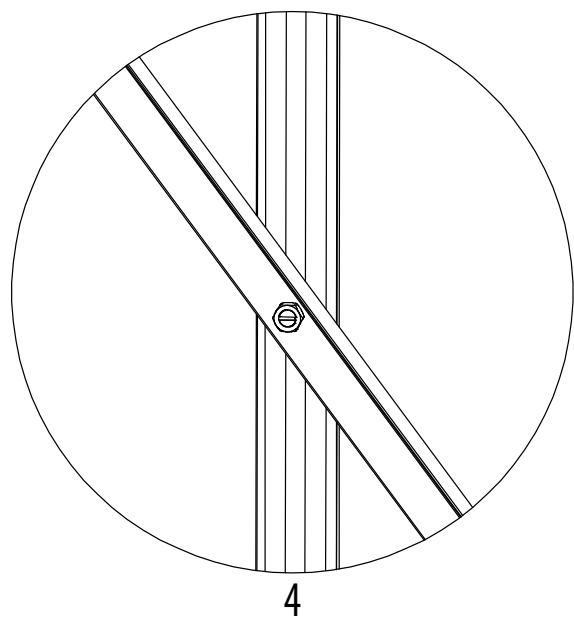
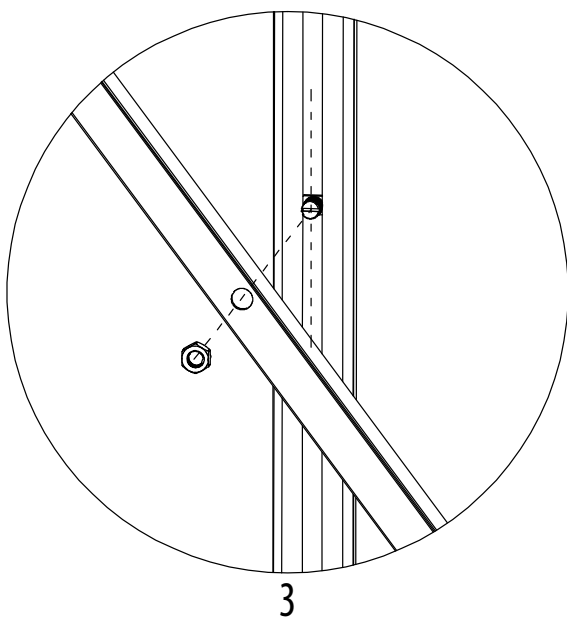
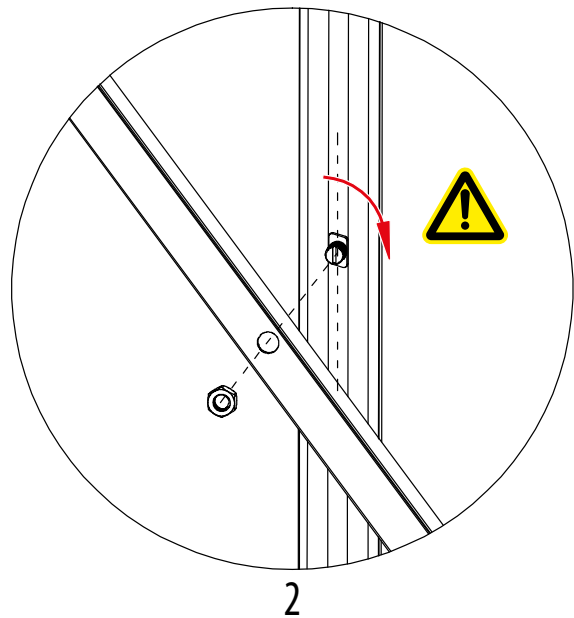
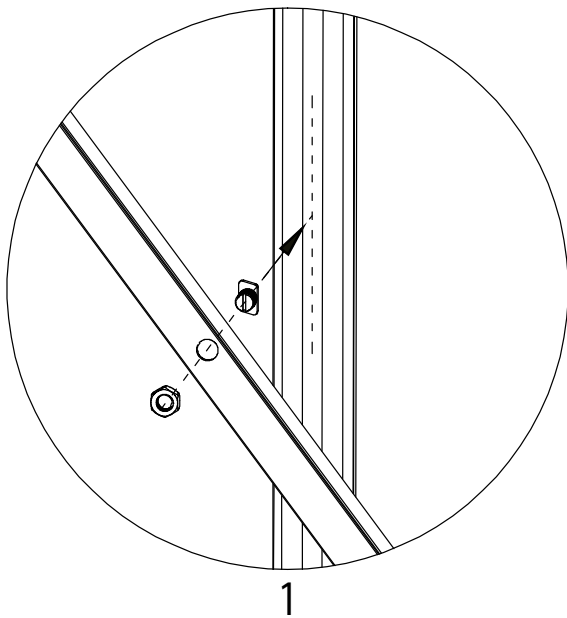





# LONG-PAN (CÔTÉ) A1 - SEITENWAND A1 - SIDE WALL A1

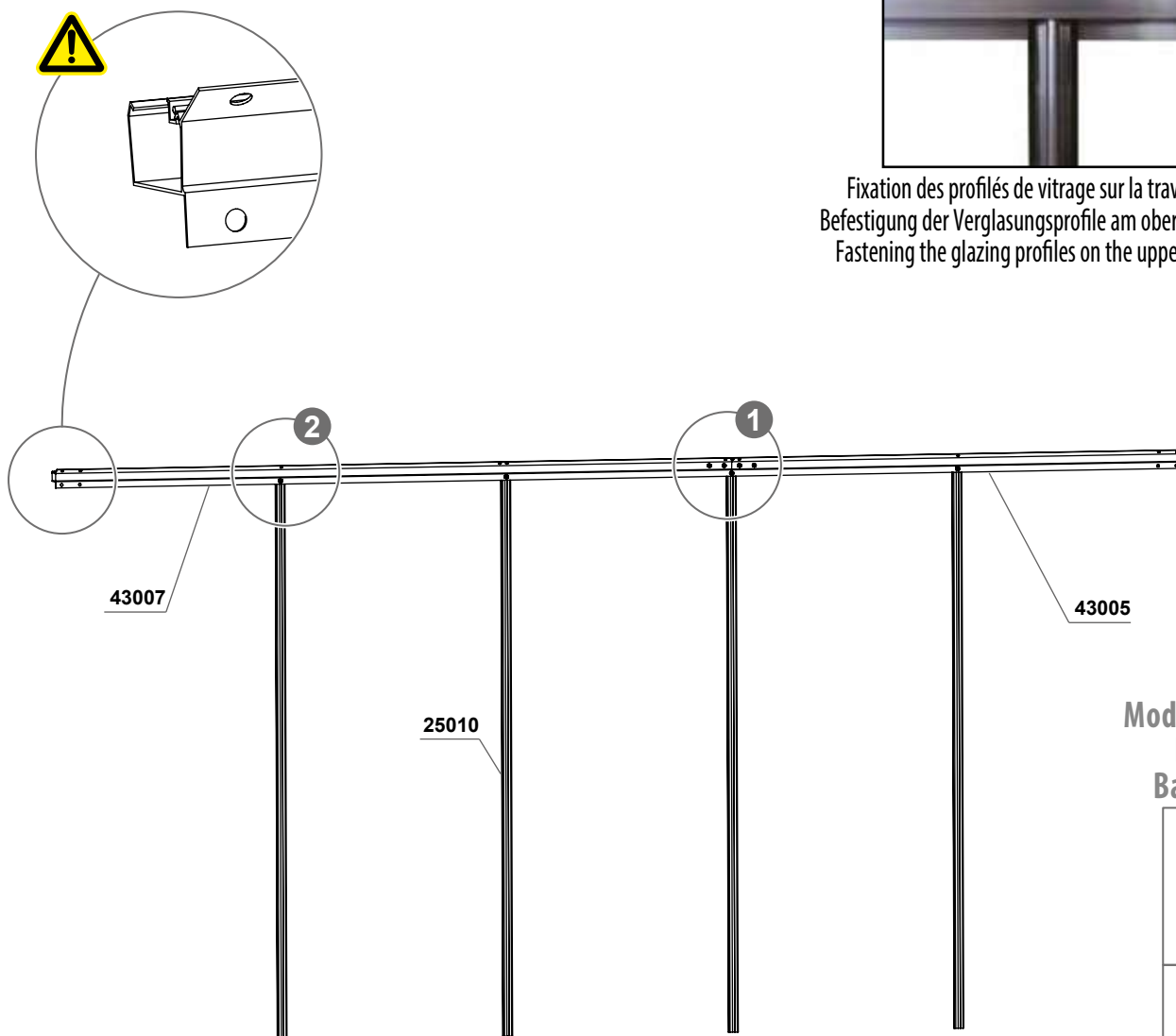

Fixation des profilés de vitrage sur la traverse haute.  
 Befestigung der Verglasungsprofile am oberen Querträger.  
 Fastening the glazing profiles on the upper crossbeam.

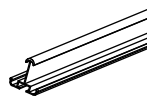
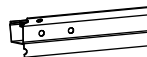

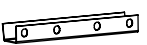
Module de base  
 Basismodul  
 Basic module

-  25010 x 4
-  43005 x 1
-  43007 x 1
-  W002 x 1
-  1001 x 8
-  1002 x 8

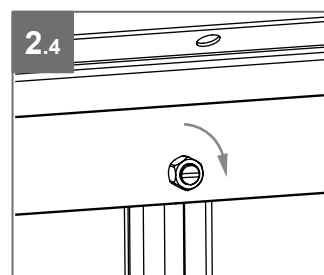
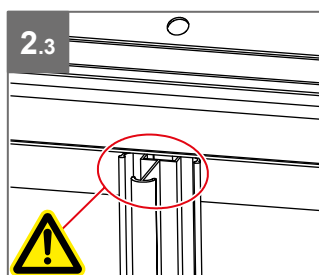
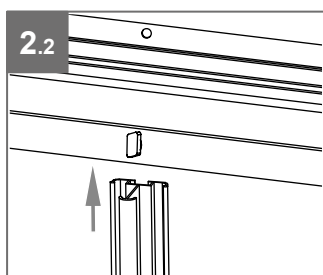
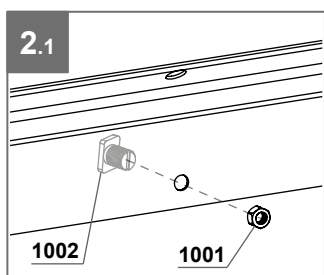
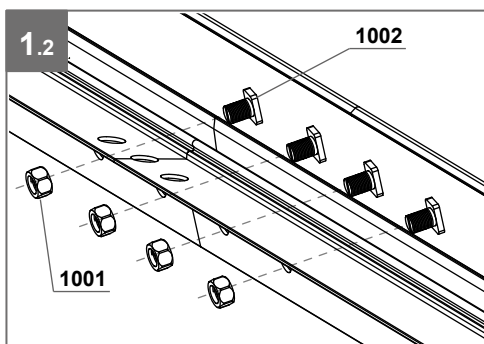
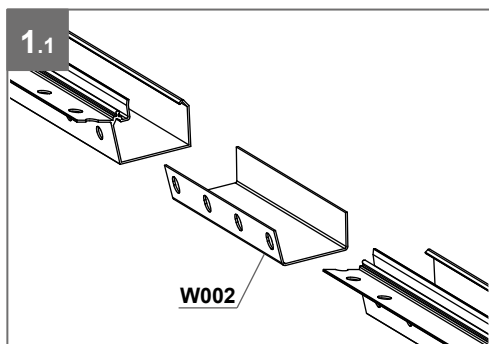



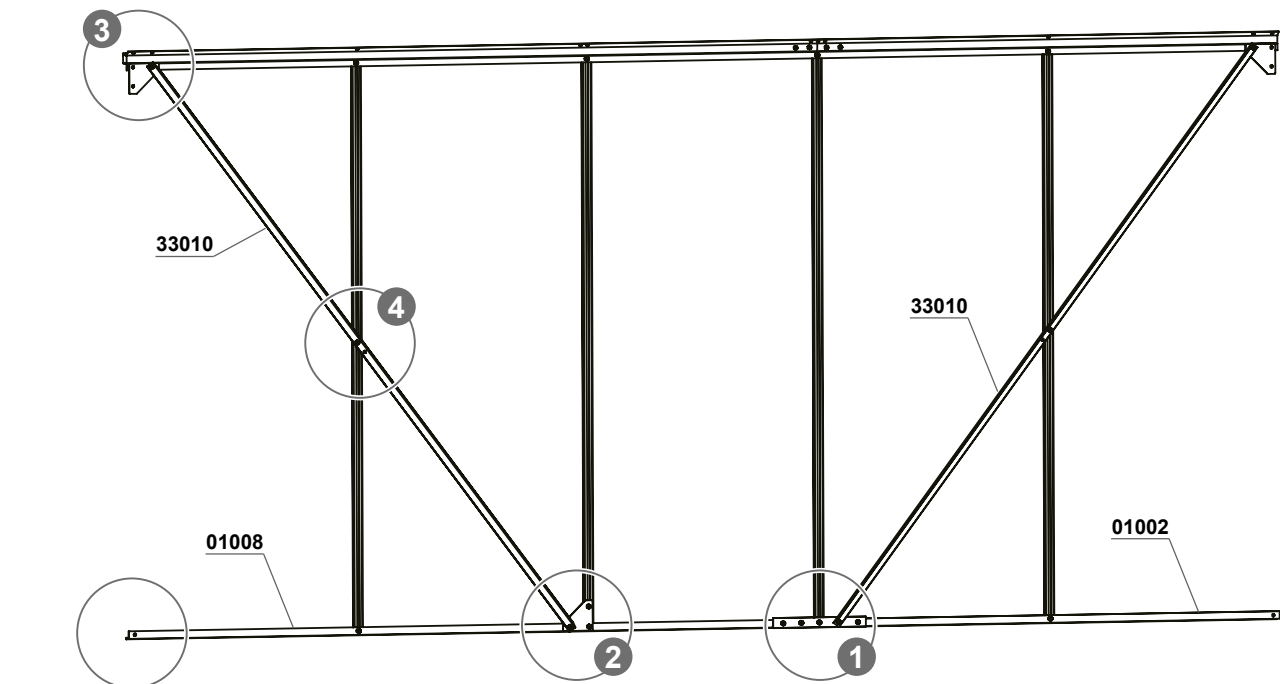

# LONG-PAN (CÔTÉ) A1 - SEITENWAND A1 - SIDE WALL A1

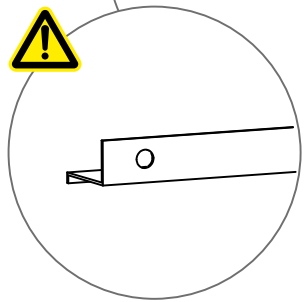

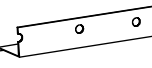
Module de base  
Basismodul  
Basic module

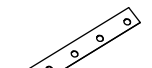

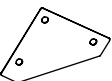
-   
01002 x 1
-   
01008 x 1
-   
33010 x 2
-   
46001 x 1
-   
1001 x 14
-   
1002 x 14
-   
W003 x 3

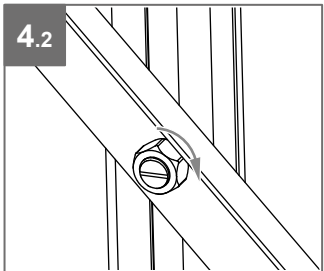
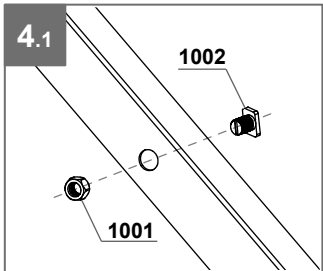
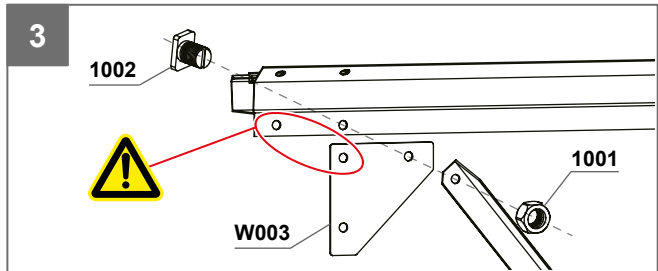
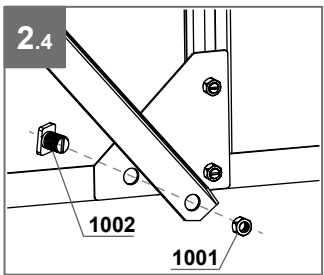
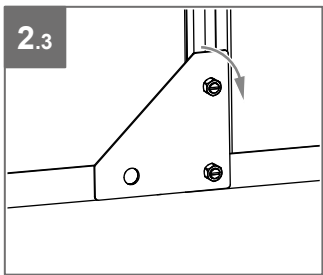
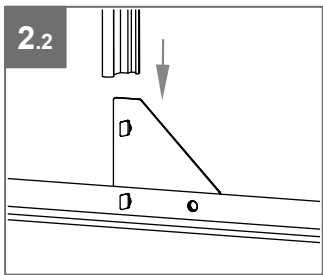
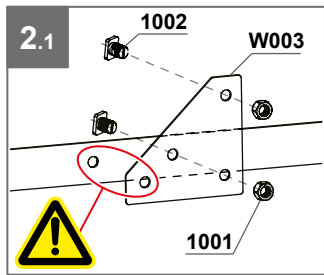
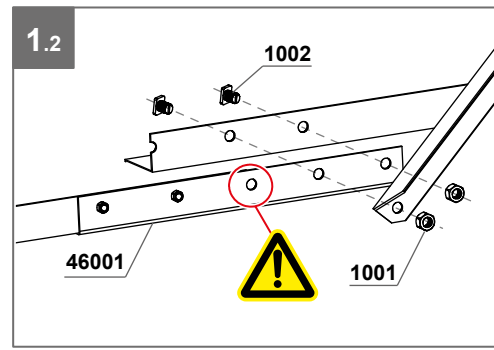
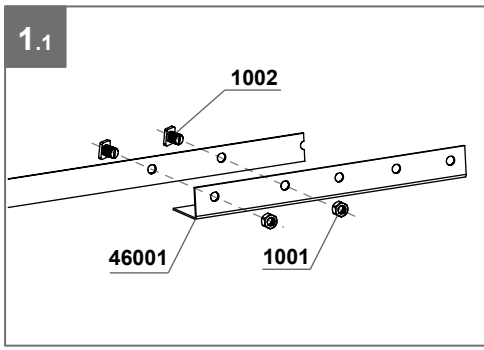



# LONG-PAN (CÔTÉ) A2 - SEITENWAND A2 - SIDE WALL A2

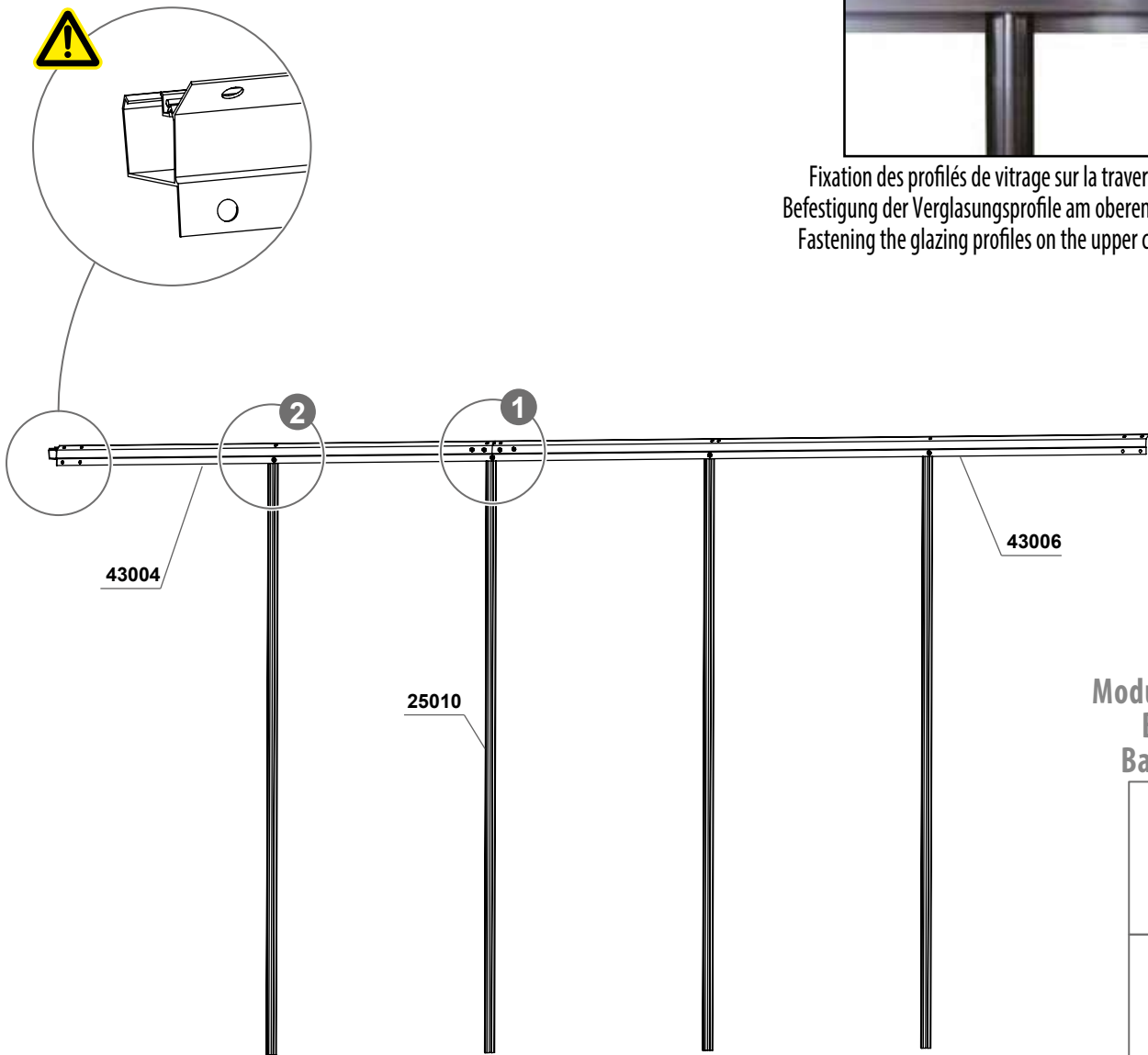

Fixation des profilés de vitrage sur la traverse haute.  
 Befestigung der Verglasungsprofile am oberen Querträger.  
 Fastening the glazing profiles on the upper crossbeam.

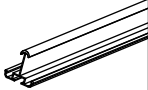
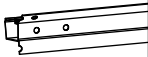
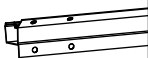
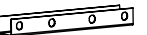

## Module de base Basismodul Basic module

-  25010 x 4
-  43006 x 1
-  43004 x 1
-  W002 x 1
-  1001 x 8
-  1002 x 8

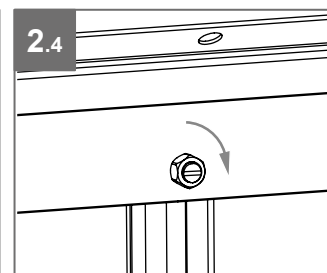
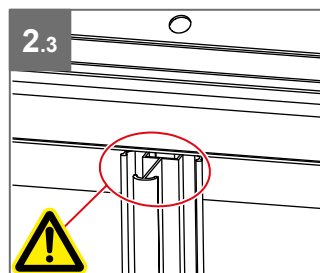
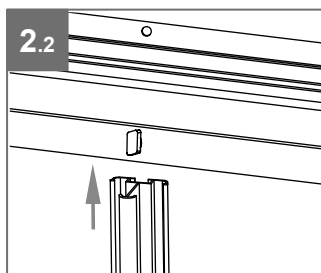
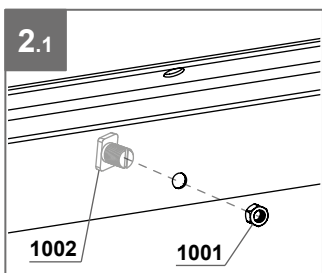
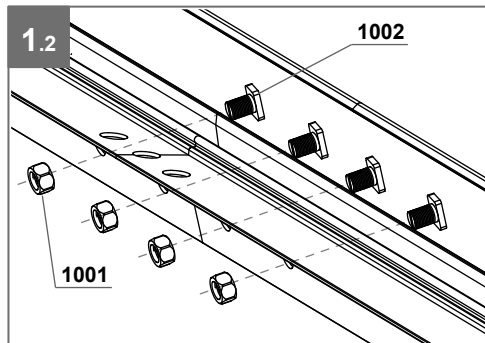
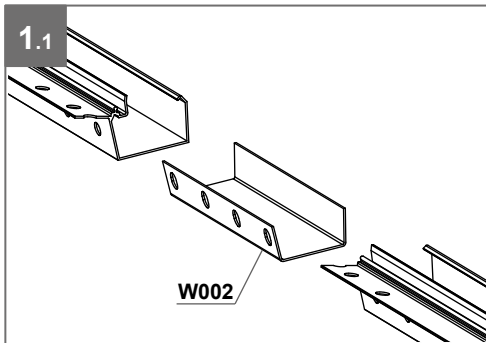



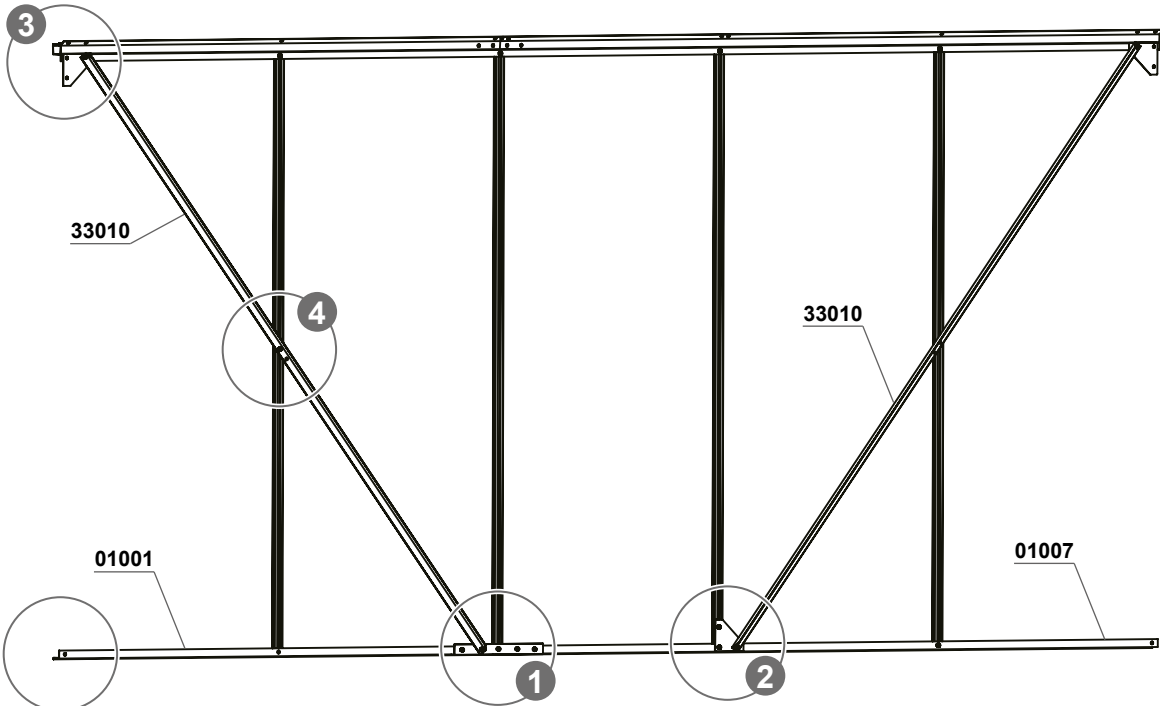

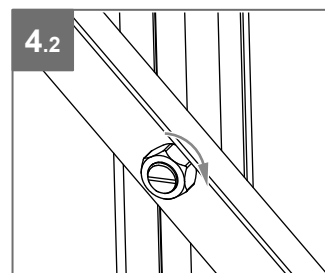
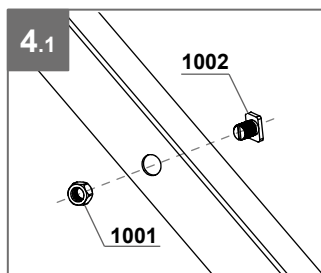
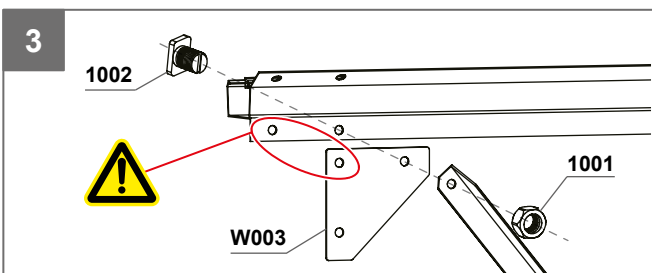
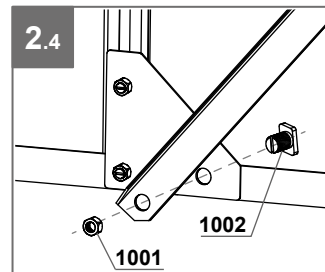
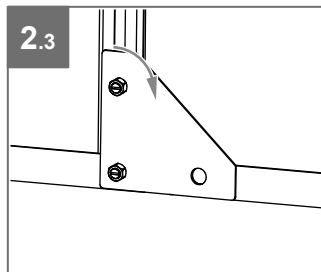
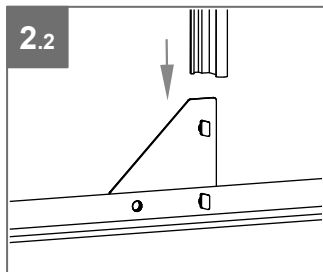
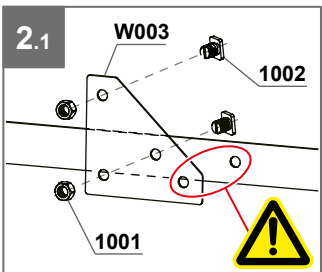
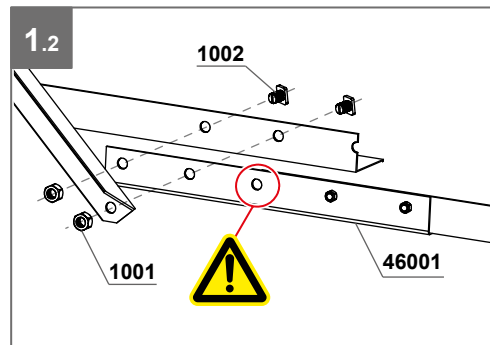
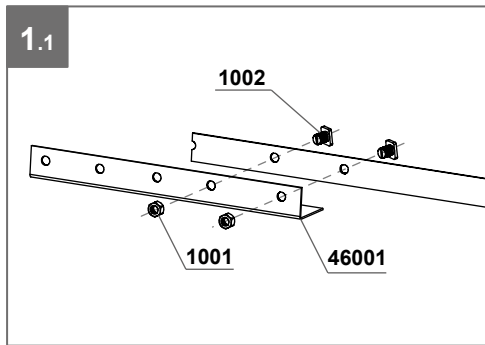
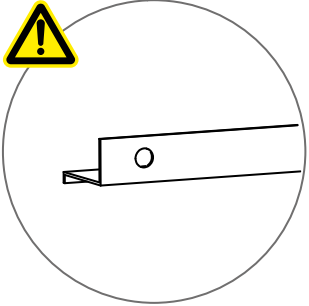

# LONG-PAN (CÔTÉ) A2 - SEITENWAND A2 - SIDE WALL A2

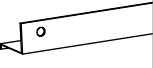
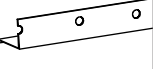

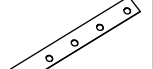
Module de base  
Basismodul  
Basic module



-   
01001 x 1
-   
01007 x 1
-   
33010 x 2
-   
46001 x 1
-   
1001 x 14
-   
1002 x 14
-   
W003 x 3



# FACE AVANT (AVEC PORTE) - VORDERWAND (MIT TÜR) FRONT WALL (WITH DOOR)

Module de base  
Basismodul  
Basic module

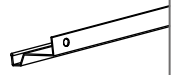
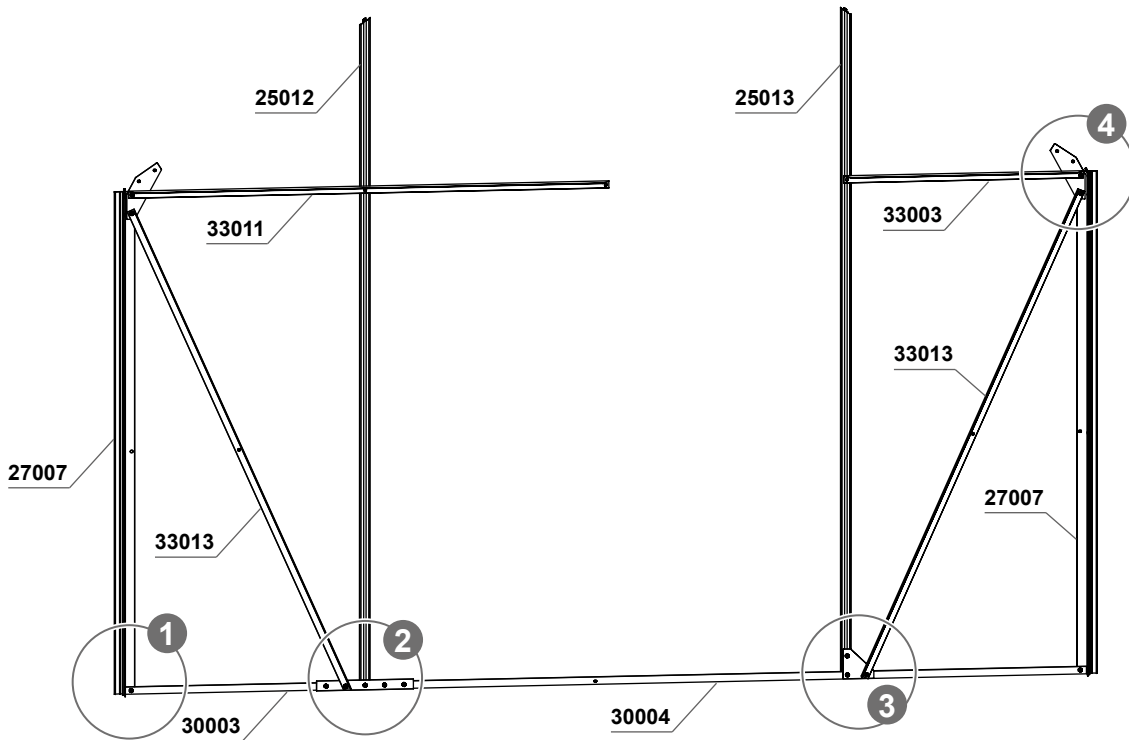

30003 x 1

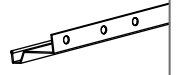

30004 x 1

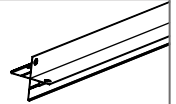

27007 x 2

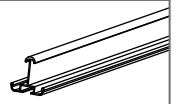

25012 x 1

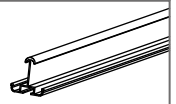

25013 x 1



33003 x 1



33011 x 1



33013 x 2

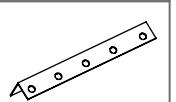

46001 x 1

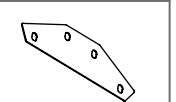

W001 x 2

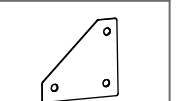

W003 x 1



1001 x 14

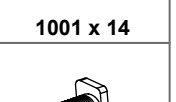

1002 x 14

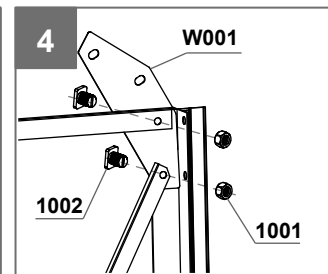
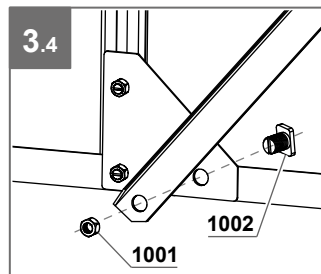
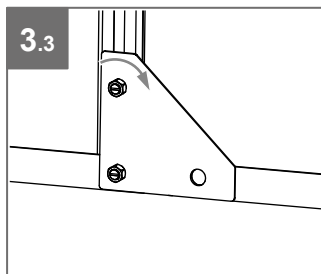
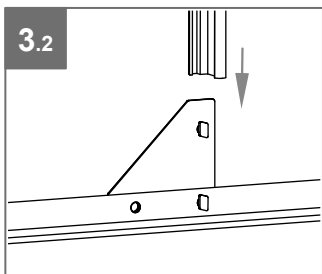
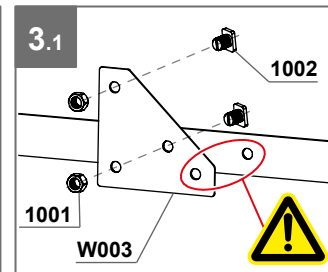
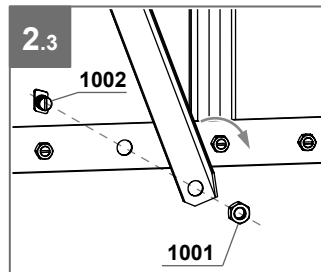
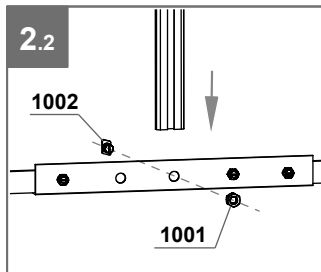
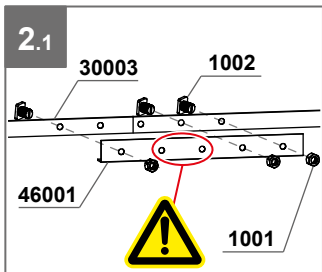
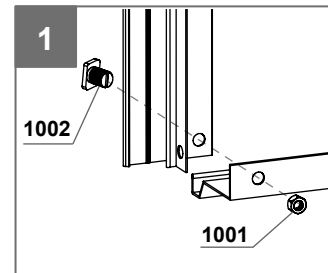

# FACE AVANT (AVEC PORTE) - VORDERWAND (MIT TÜR) FRONT WALL (WITH DOOR)

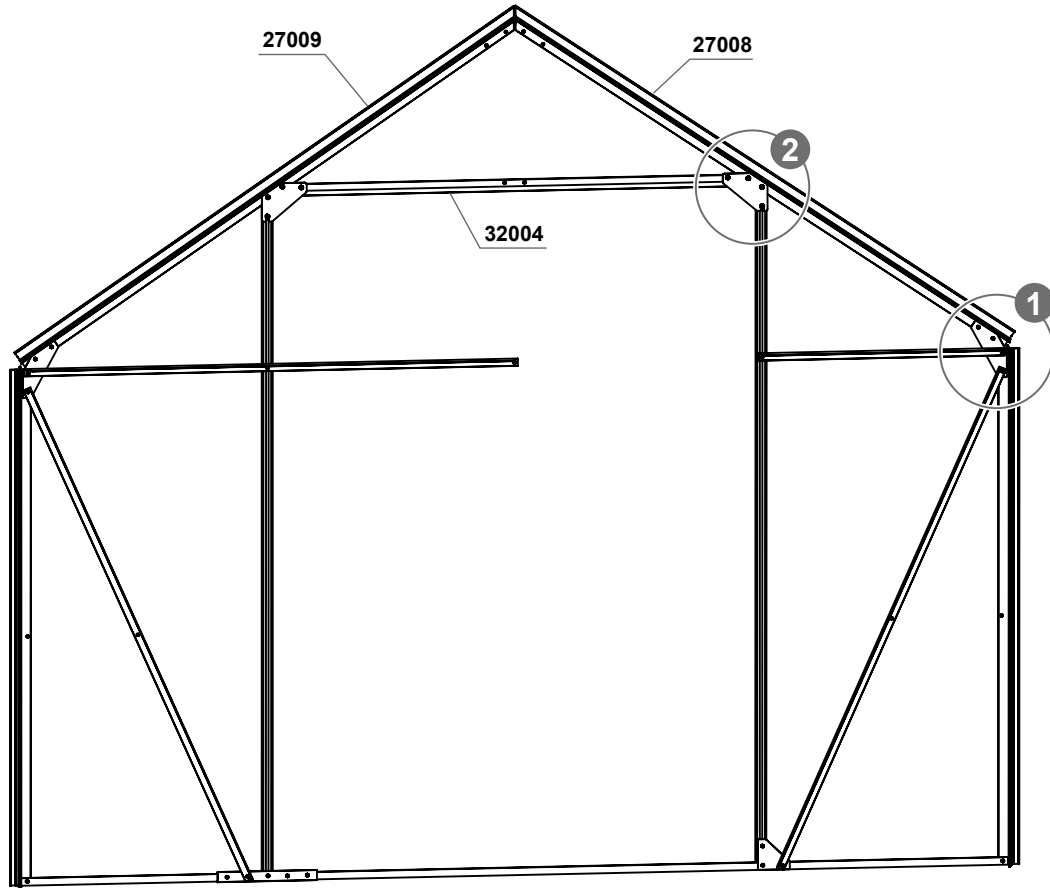

Module de base  
Basismodul  
Basic module

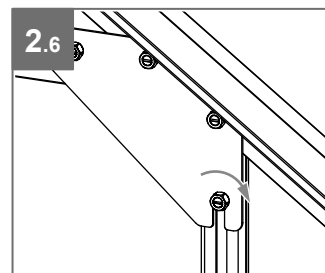
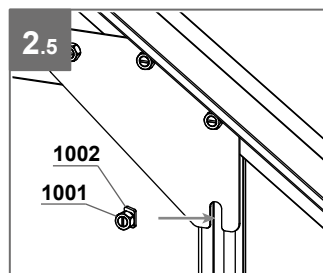
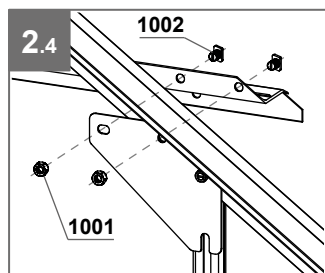
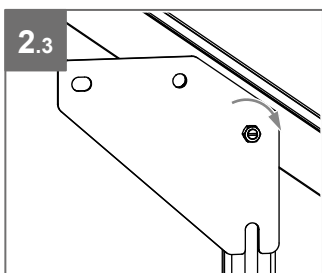
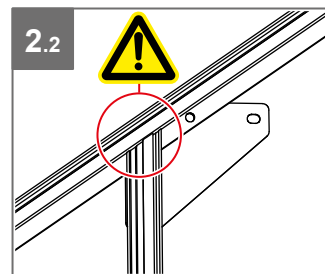
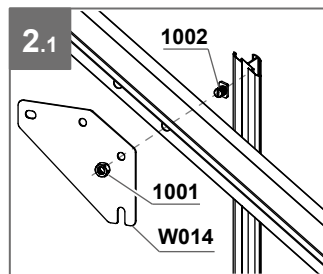
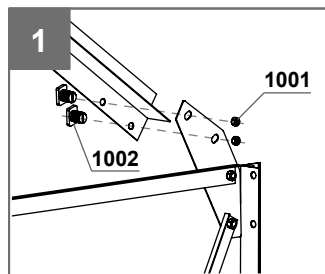
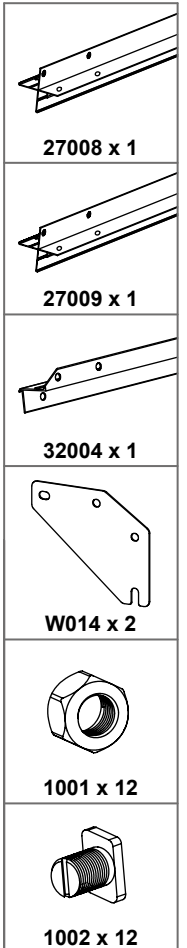

# FACE AVANT (AVEC PORTE) - VORDERWAND (MIT TÜR) FRONT WALL (WITH DOOR)

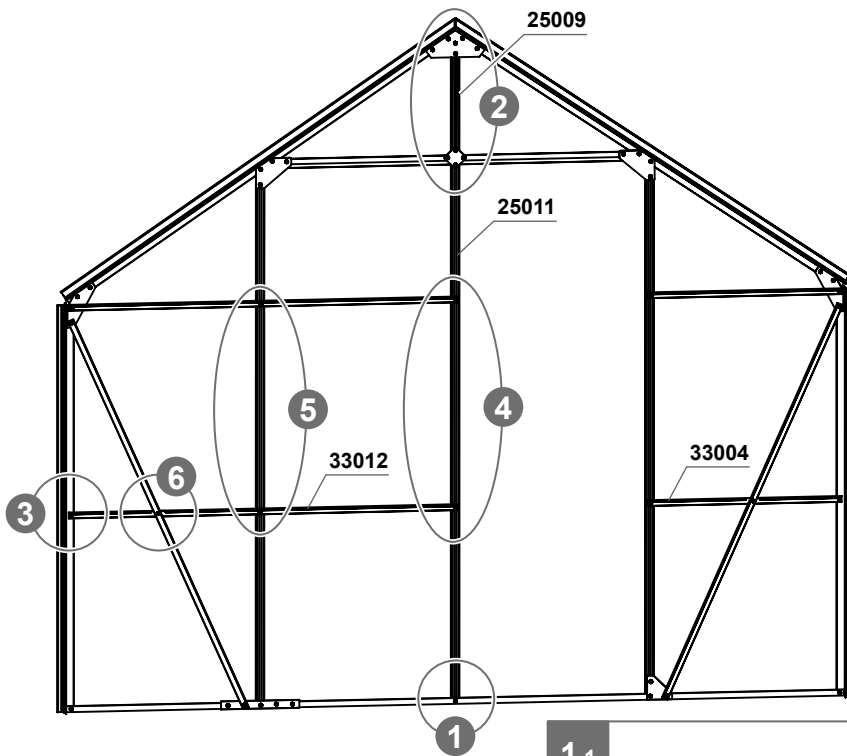

Module de base  
Basismodul  
Basic module

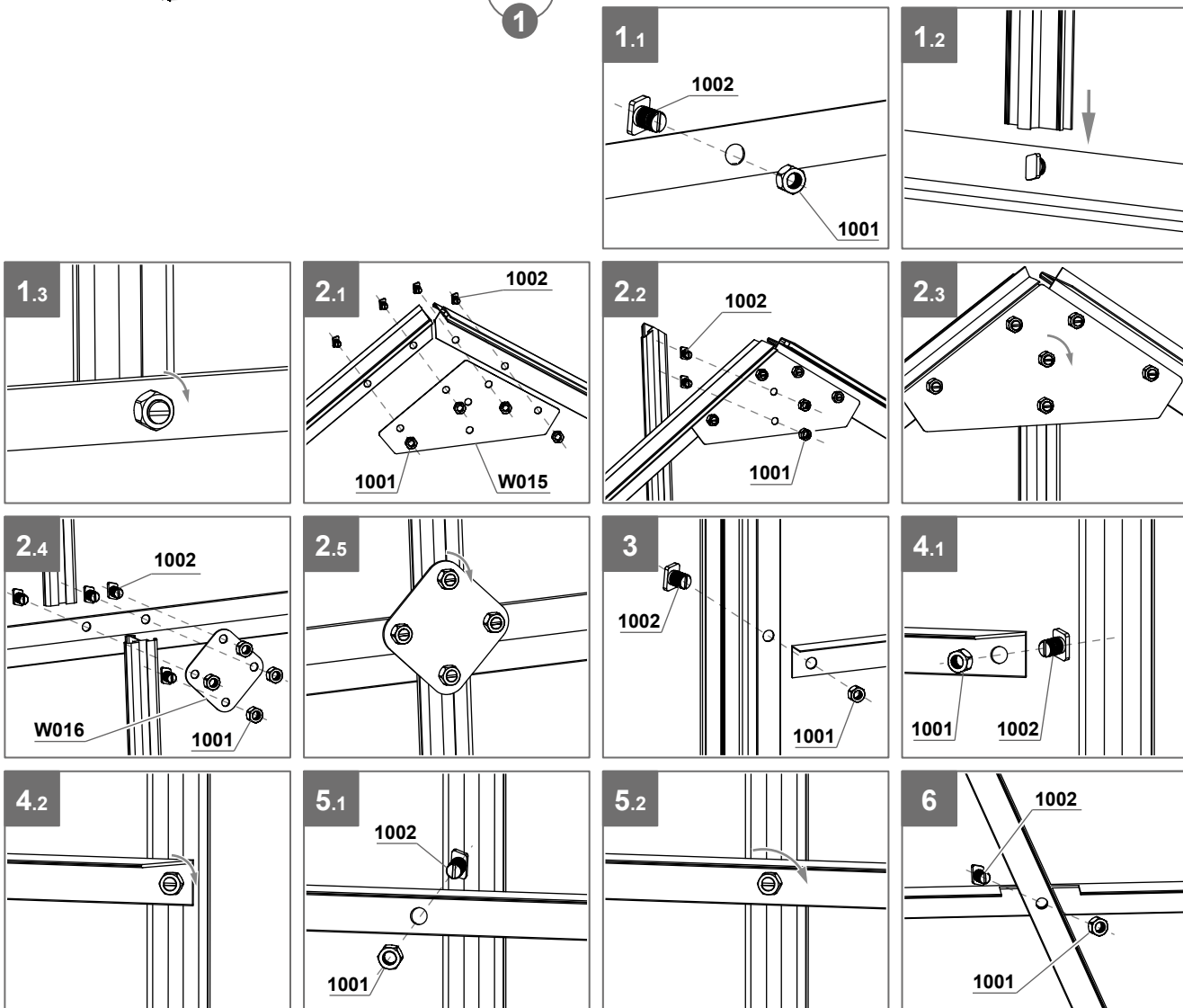
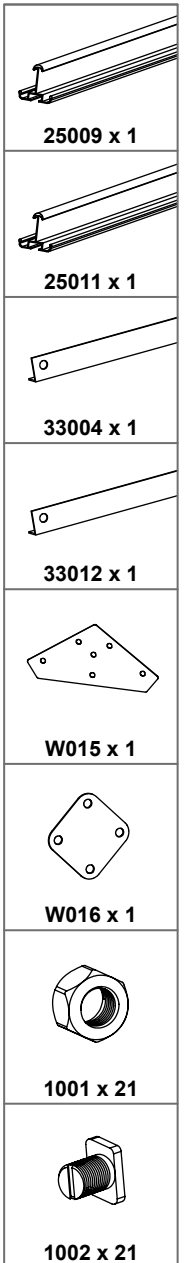

# FACE ARRIÈRE (SANS PORTE) - RÜCKWAND (OHNE TÜR) REAR WALL (WITHOUT DOOR)

Module de base  
Basismodul  
Basic module

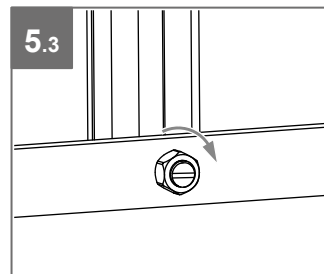
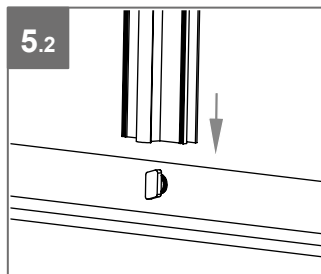
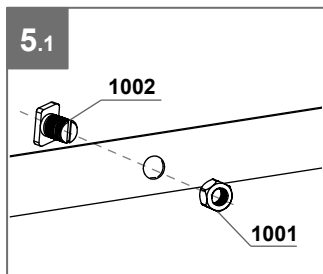
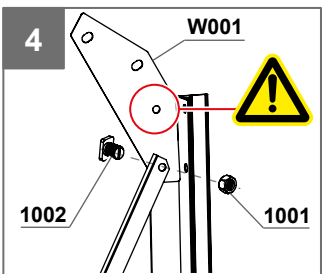
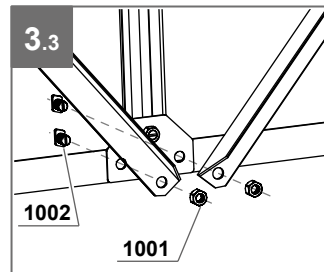
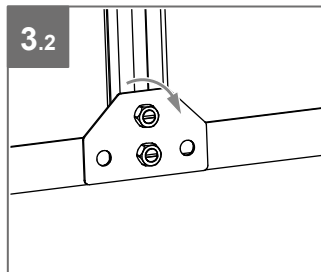
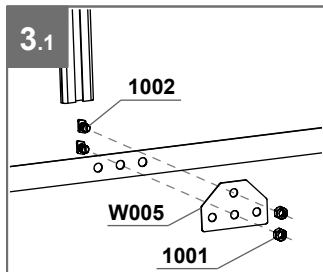
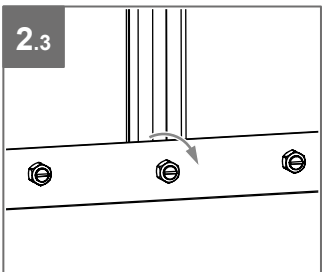
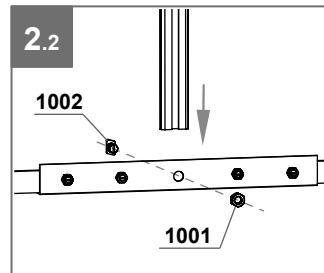
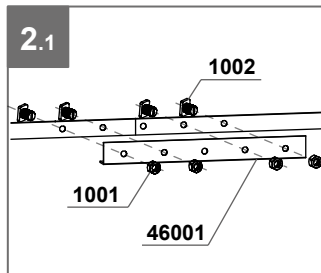
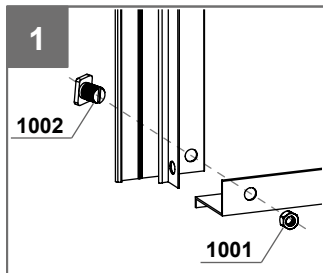
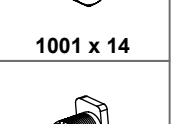
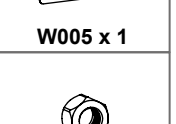
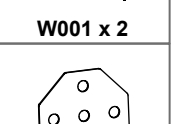
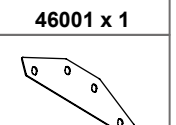
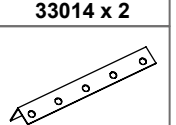
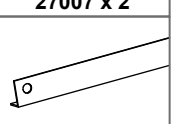
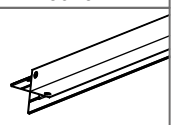
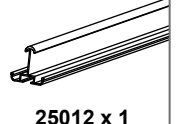
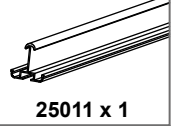
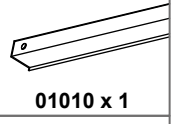
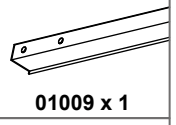
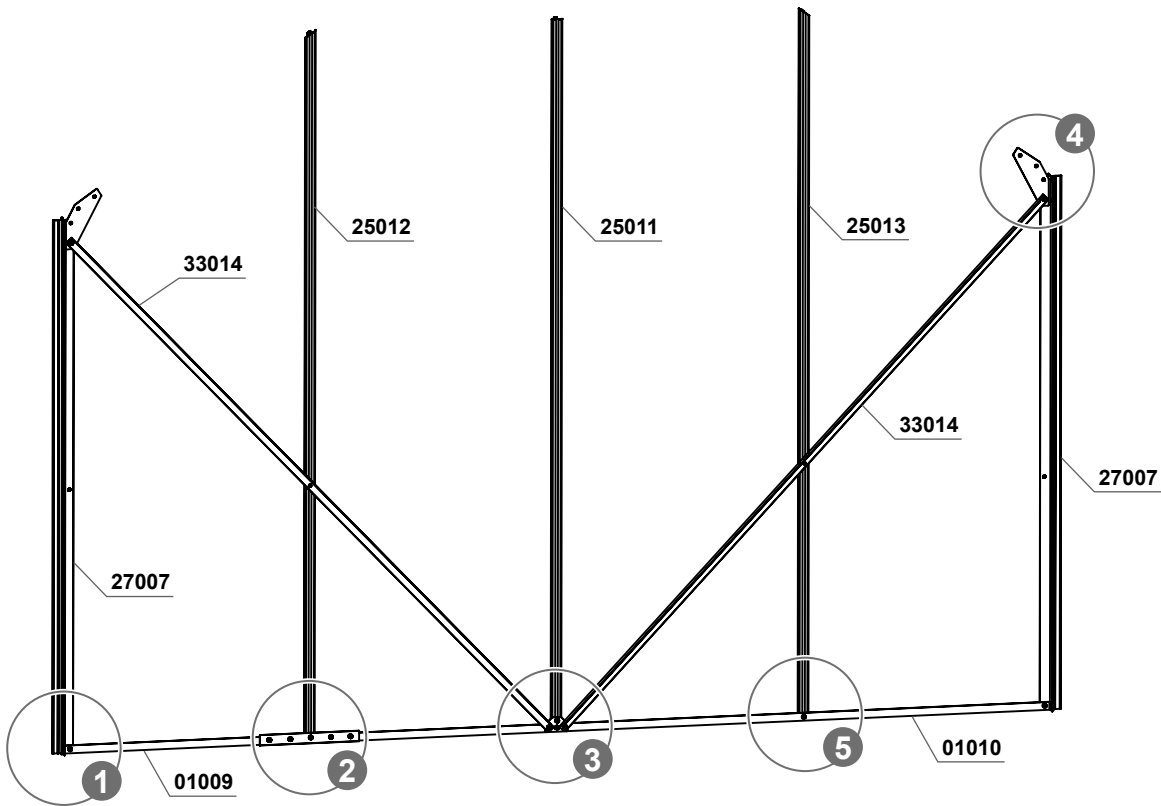

# FACE ARRIÈRE (SANS PORTE) - RÜCKWAND (OHNE TÜR) REAR WALL (WITHOUT DOOR)

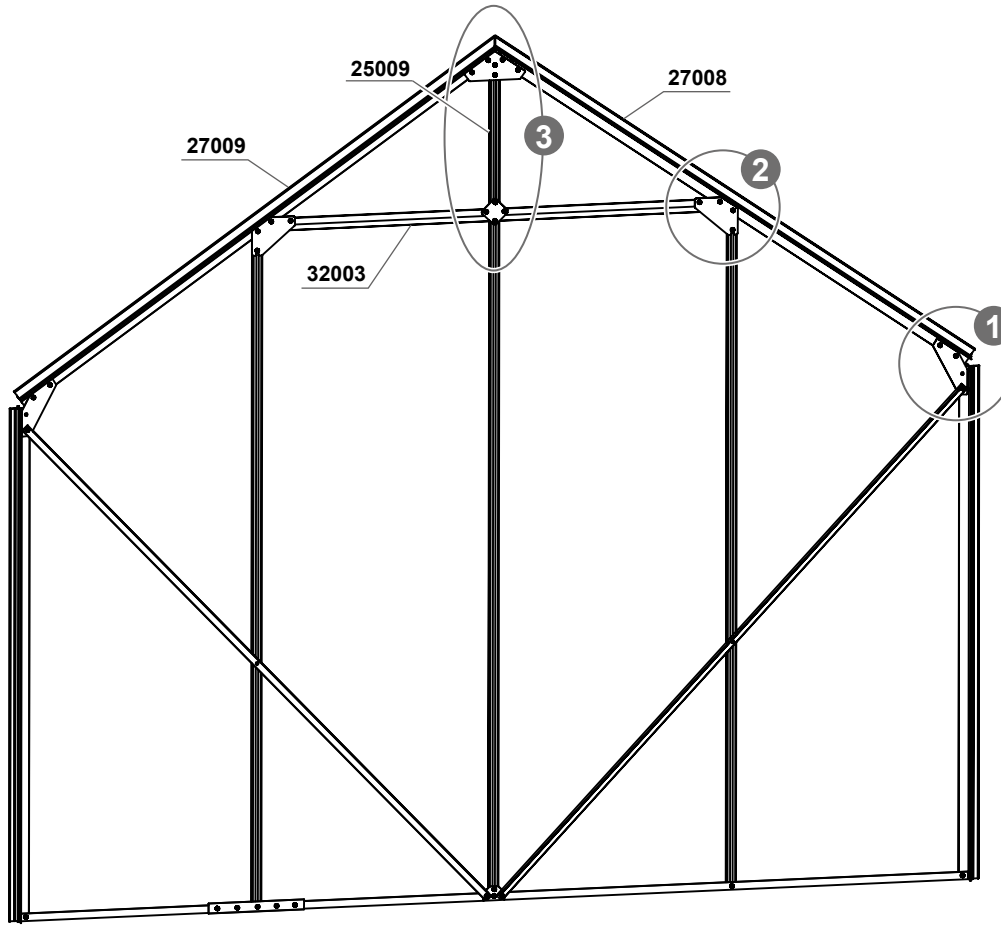

Module de base  
Basismodul  
Basic module

	25009 x 1
	27008 x 1
	27009 x 1
	32003 x 1
	W014 x 2
	W015 x 1
	W016 x 1
	1001 x 22
	1002 x 22

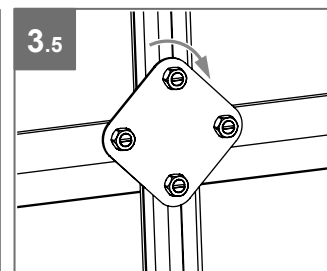
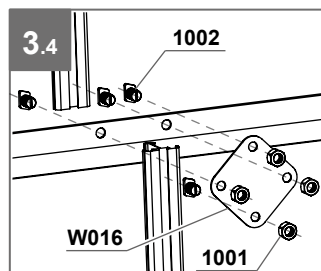
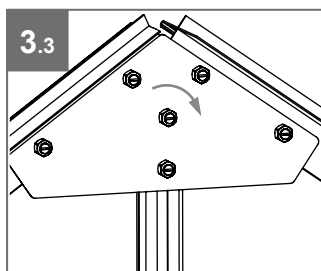
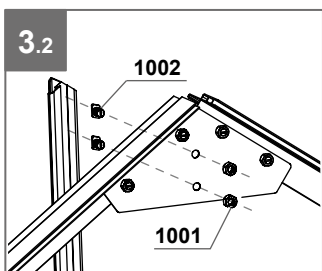
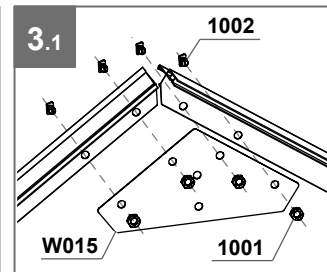
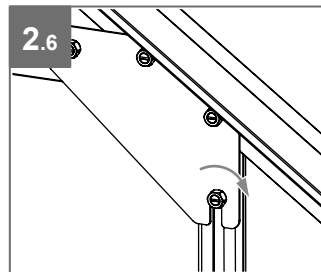
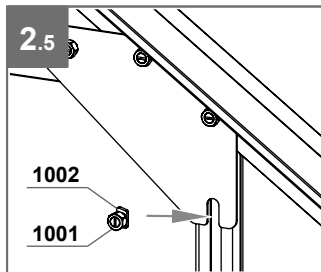
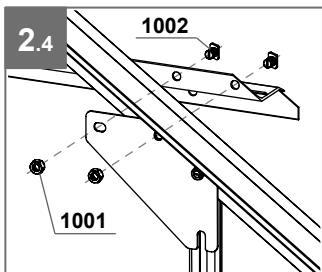
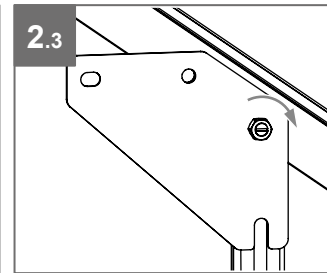
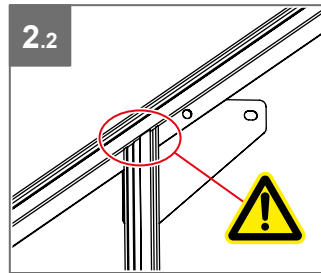
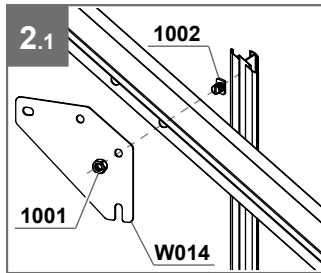
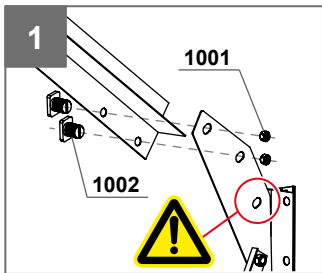

# FACE ARRIÈRE (SANS PORTE) - RÜCKWAND (OHNE TÜR)

## REAR WALL (WITHOUT DOOR)

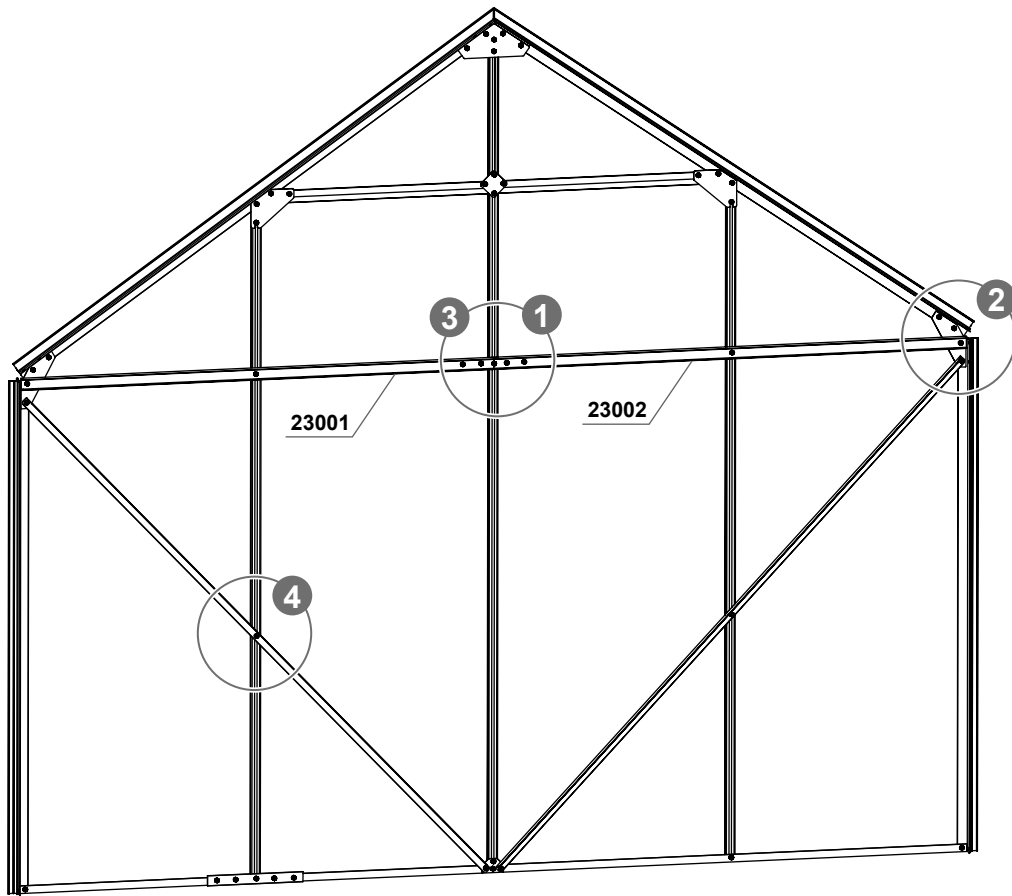

Module de base  
Basismodul  
Basic module

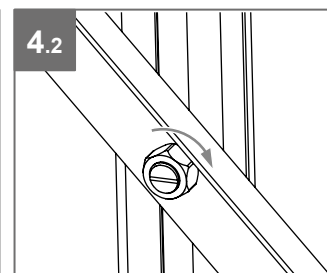
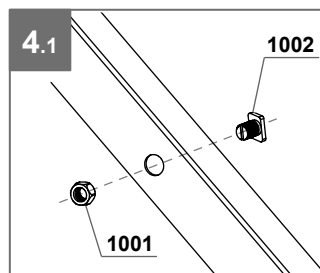
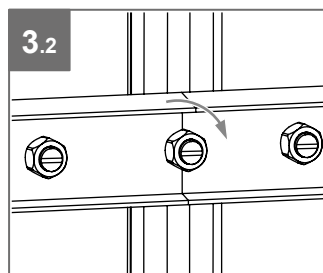
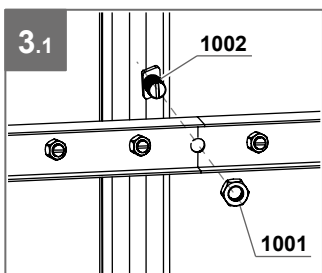
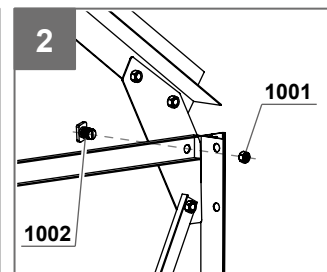
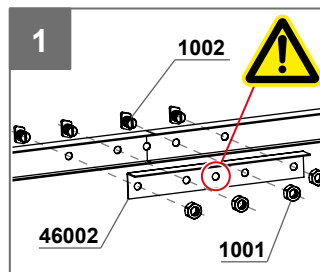
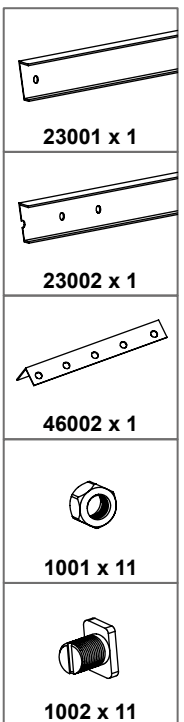

# PORTE - TÜR - DOOR

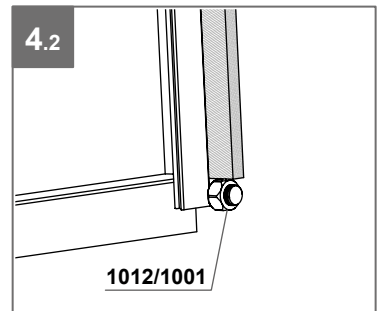
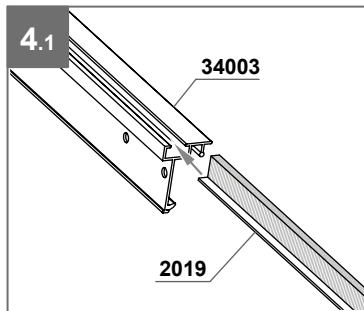
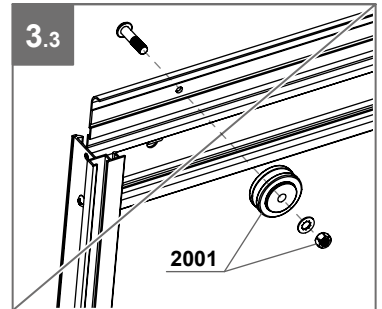
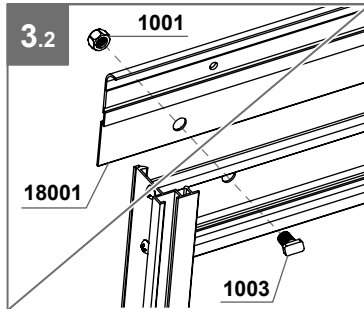
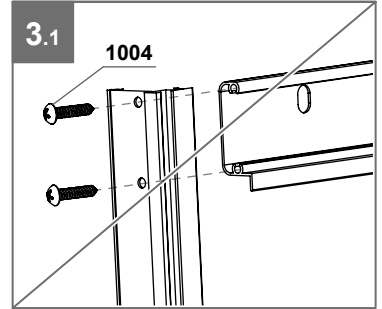
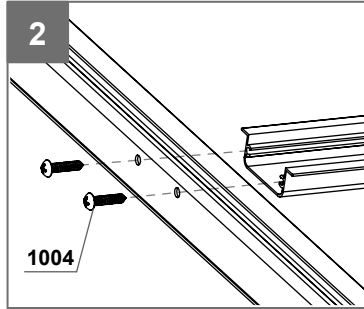
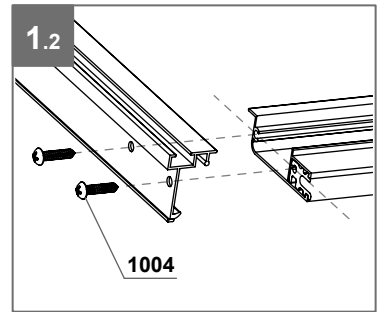
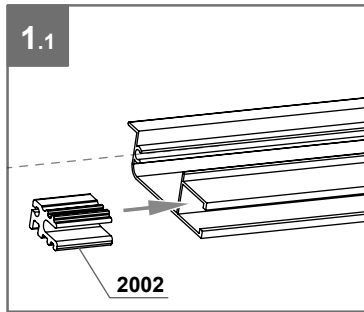
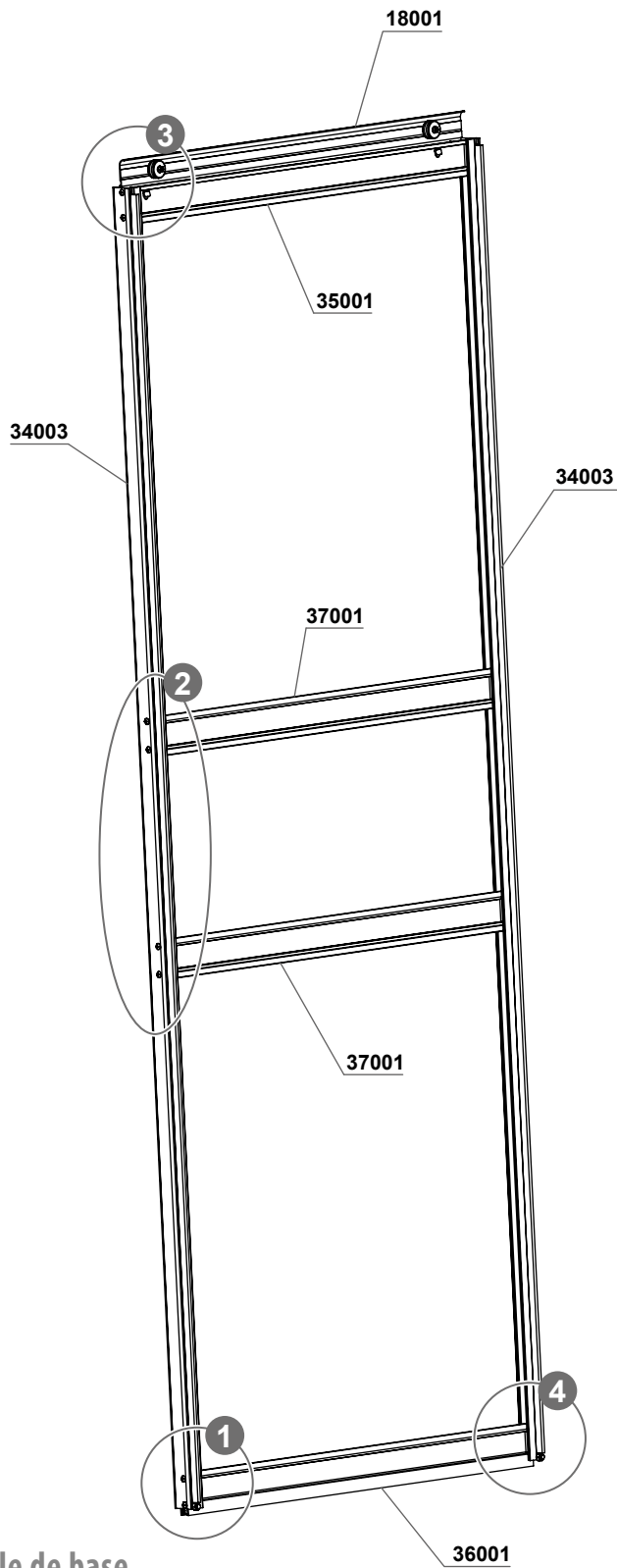

Module de base  
Basismodul  
Basic module

36001 x 1	37001 x 2	2001 x 2	2002 x 2	2019 x 2	1001 x 4	1003 x 2	1004 x 16	1012 x 2

18001 x 1	34003 x 2	35001 x 1

# LUCARNE - FENSTER - WINDOW

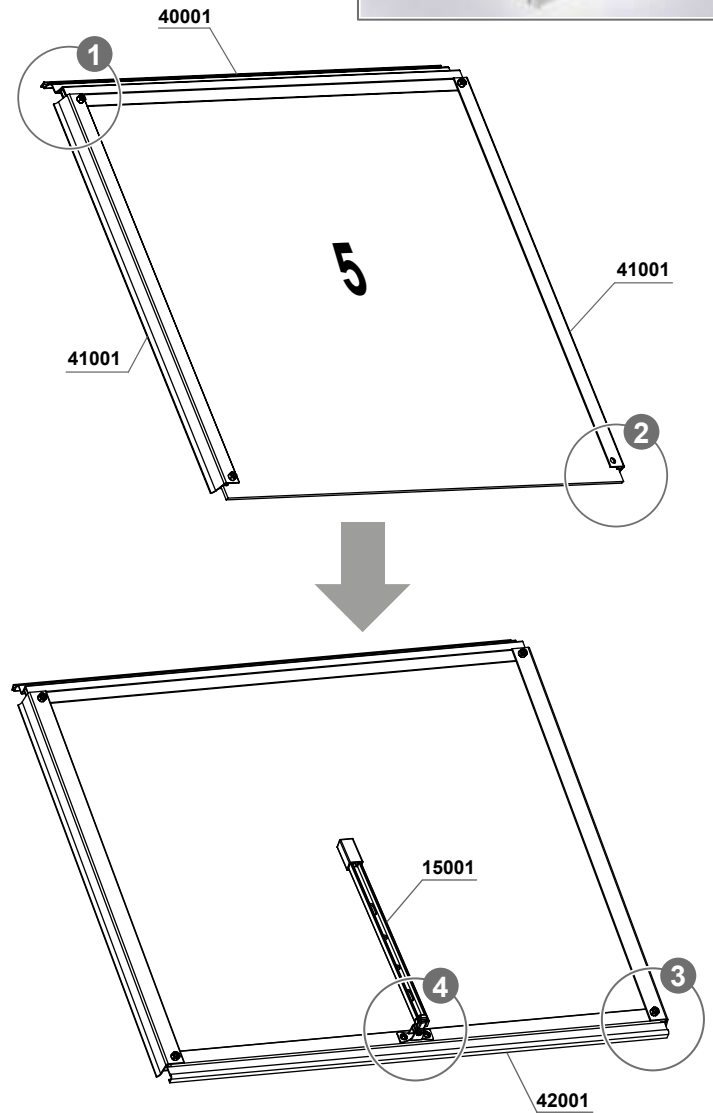
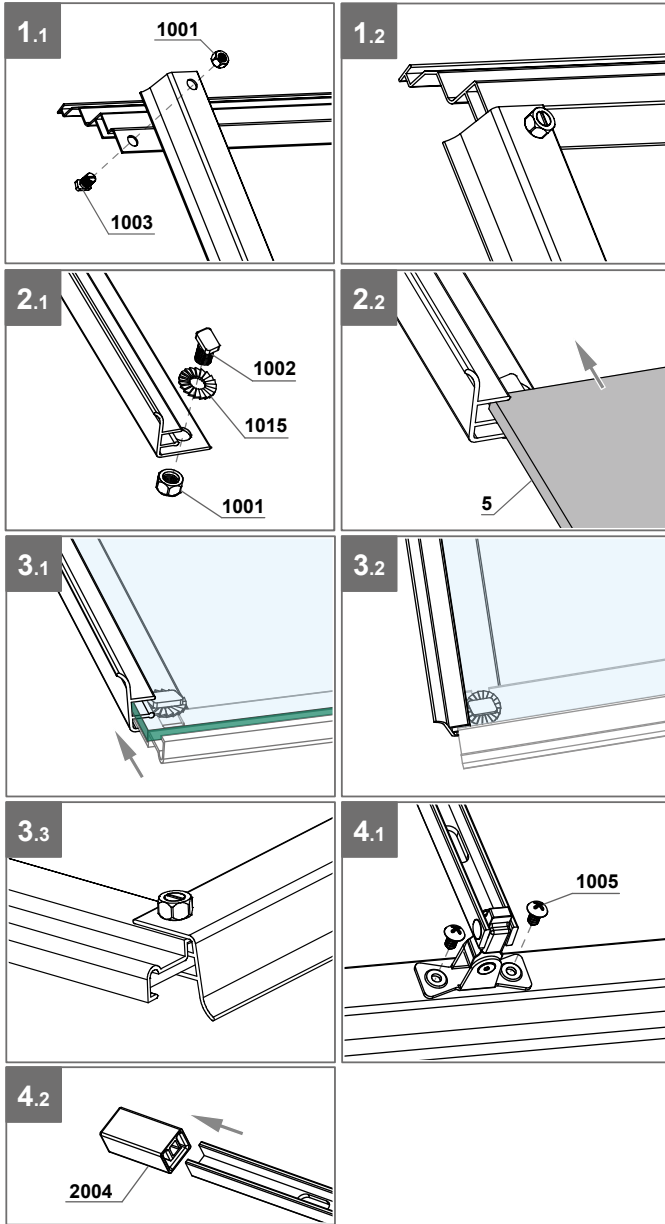

## Module de base - Basismodul - Basic module

40001 x 2	41001 x 4	42001 x 2	2004 x 2	1001 x 8	1002 x 4	1003 x 4	1005 x 4	1015 x 4
600 x 544 mm								
5 x 2	15001 x 2							



# ASSEMBLAGE DES PAROIS - ZUSAMMENBAU DER WÄNDE

## ASSEMBLY OF THE WALLS

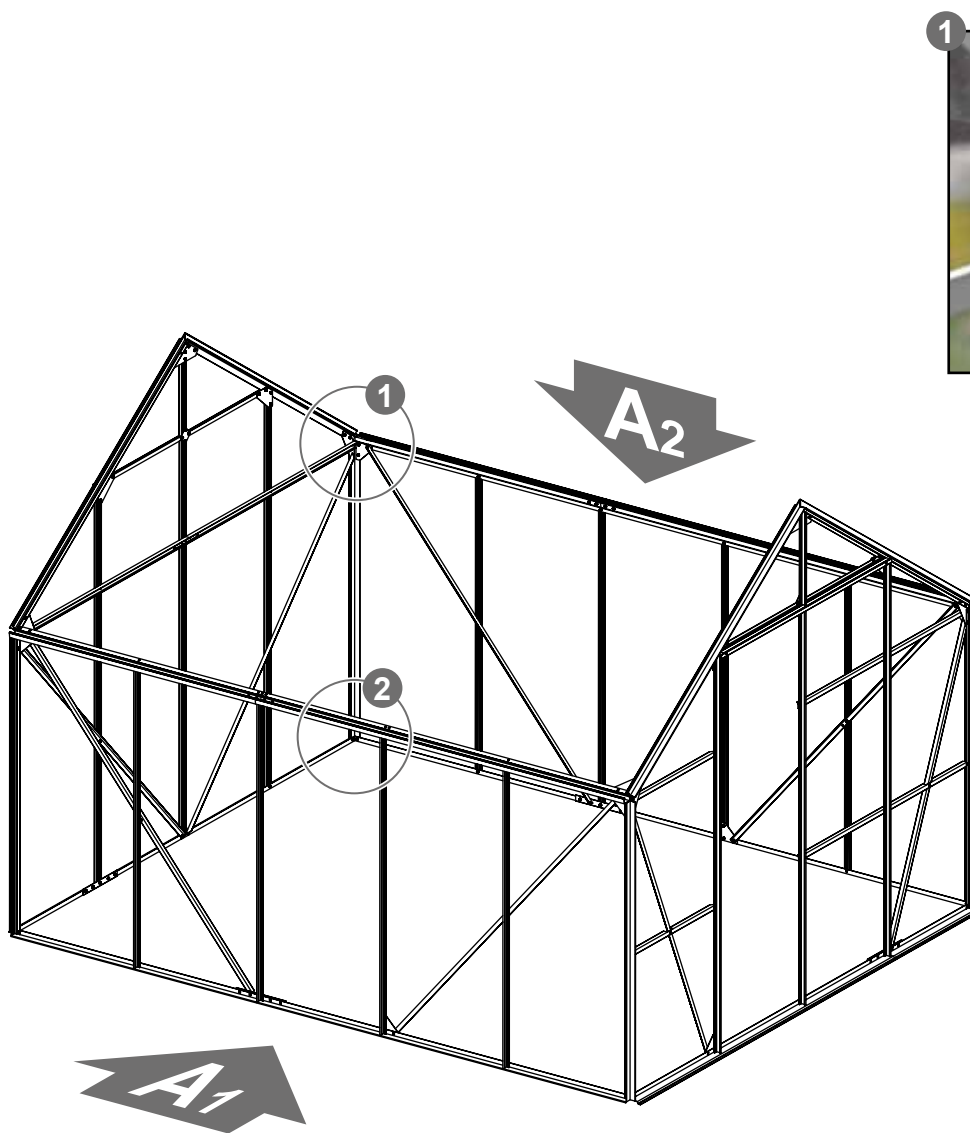

Module de base  
Basismodul  
Basic module

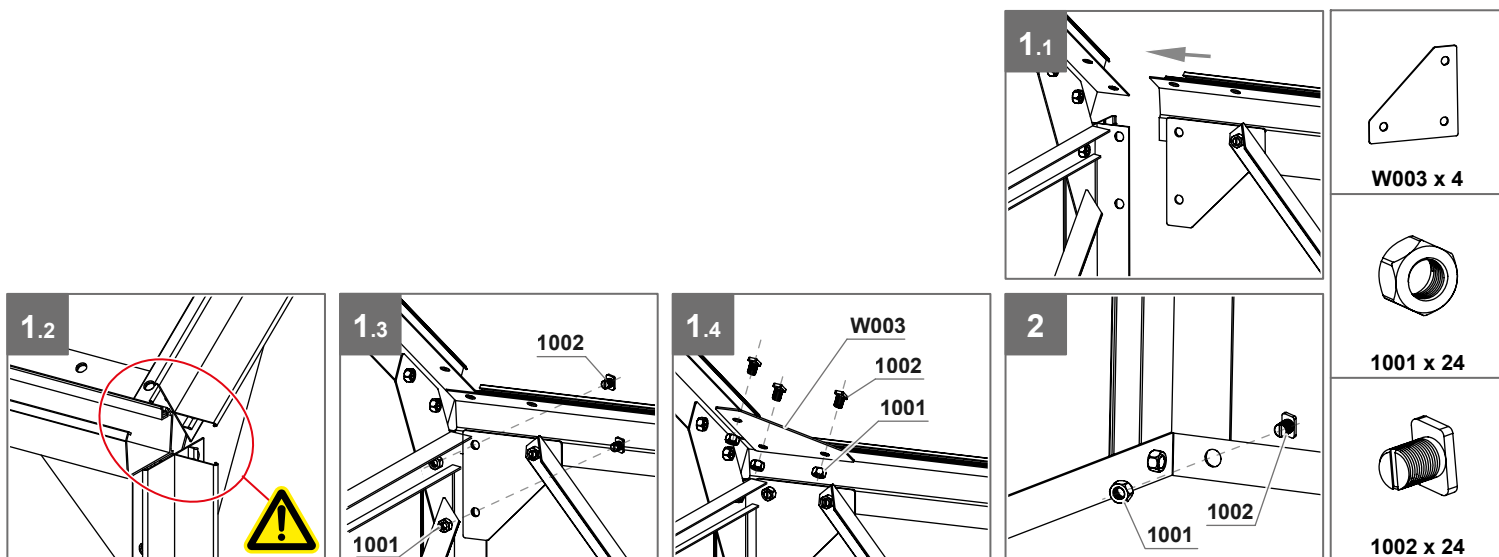

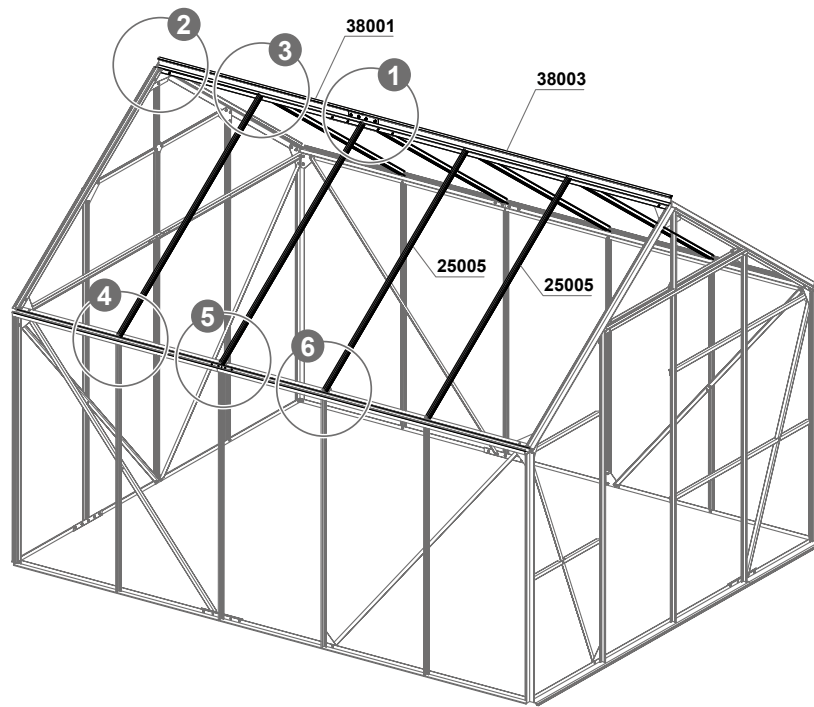

# MONTAGE DES PROFILÉS DE TOITURE - MONTAGE DER DACHPROFILE ASSEMBLING THE ROOF PROFILES

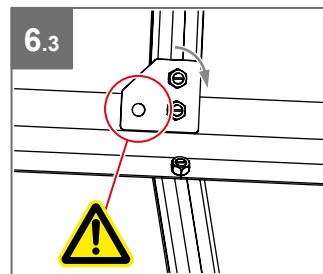
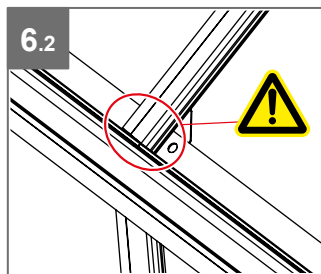
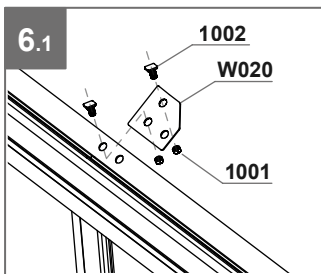
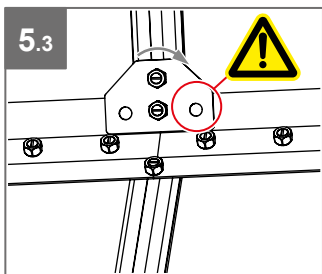
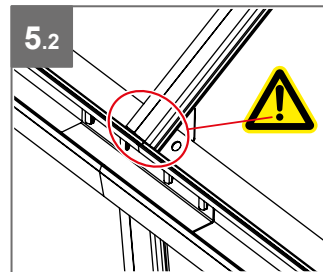
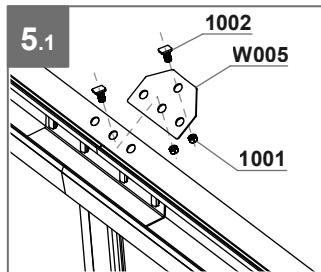
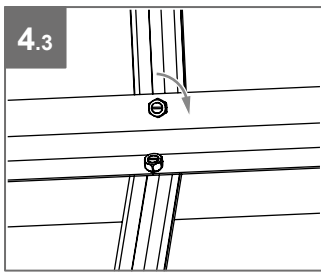
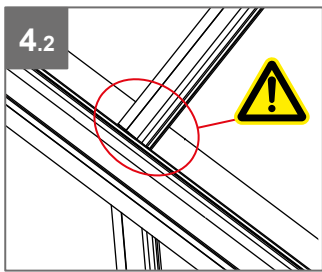
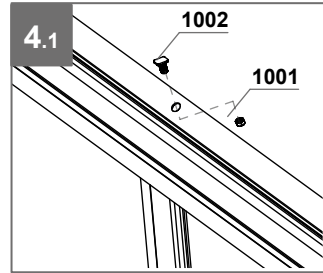
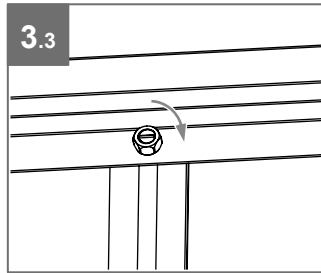
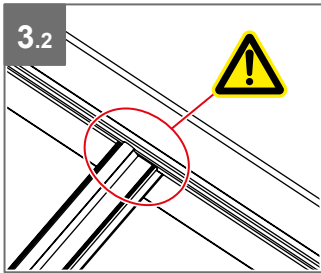
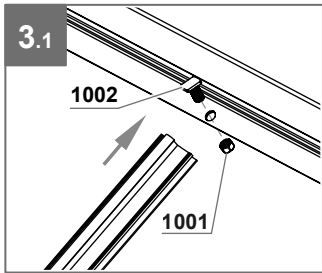
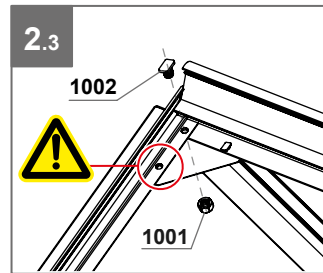
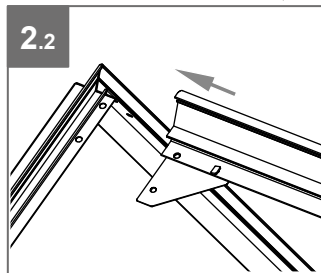
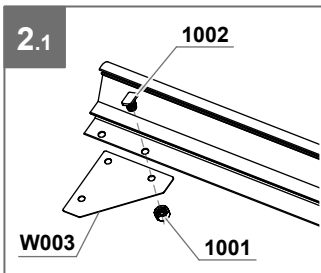
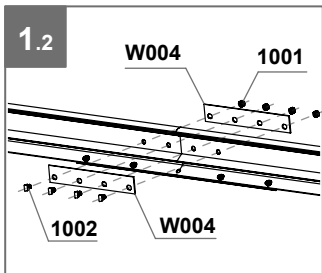
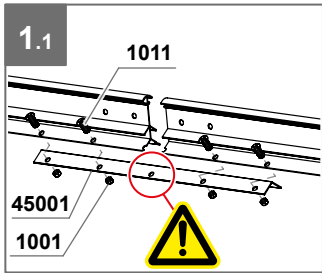

Module de base  
Basismodul  
Basic module

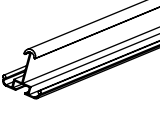
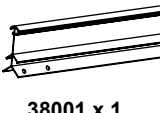
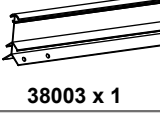
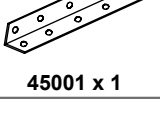
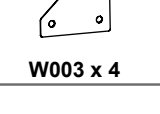
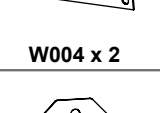
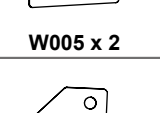
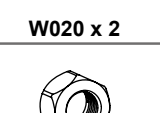
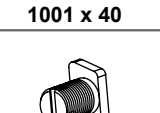

-  25005 x 8
-  38001 x 1
-  38003 x 1
-  45001 x 1
-  W003 x 4
-  W004 x 2
-  W005 x 2
-  W020 x 2
-  1001 x 40
-  1002 x 32
-  1011 x 8

# MONTAGE DES TENDEURS ET GOUSSETS SPANNVORRICHTUNG UND VERBINDER WIND BRACES AND GUSSETS

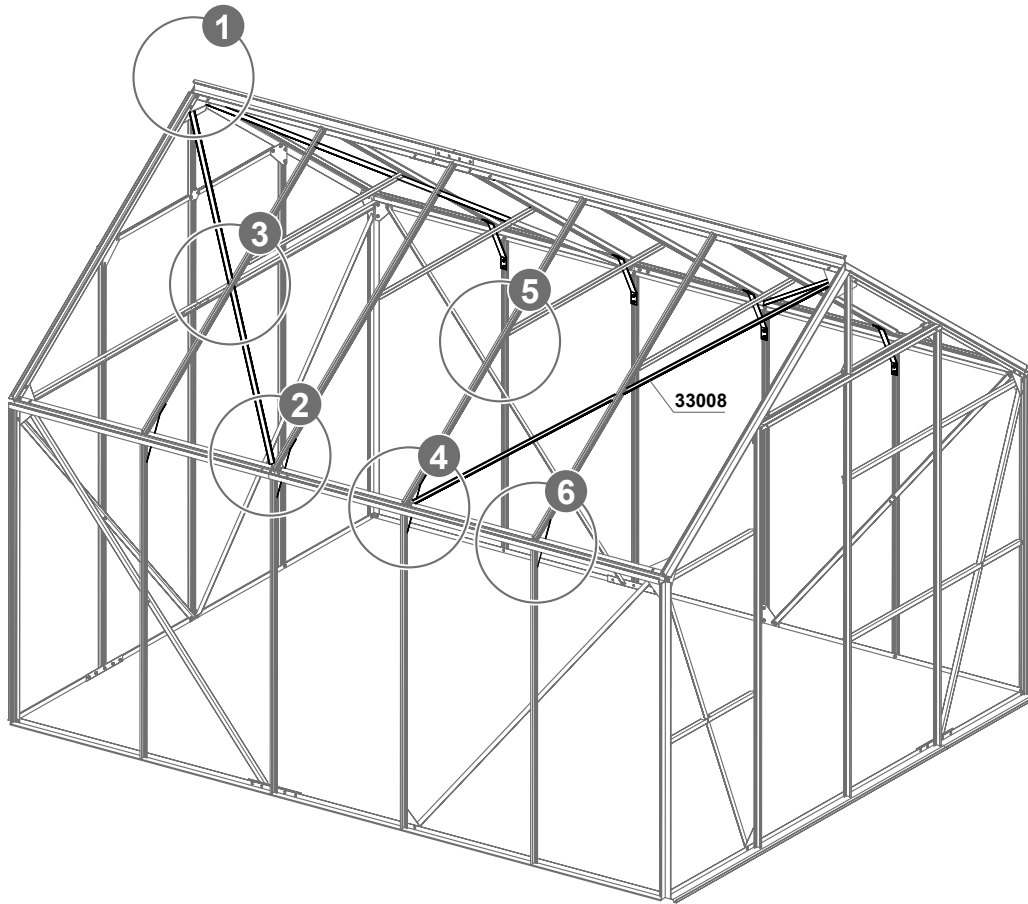

Module de base  
Basismodul  
Basic module

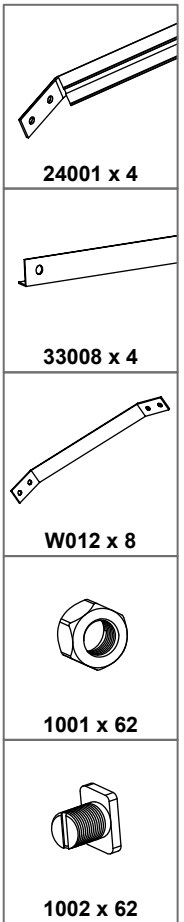
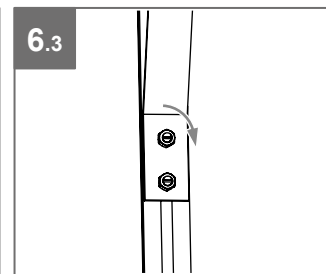
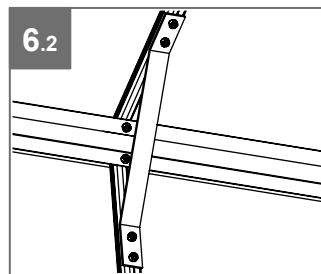
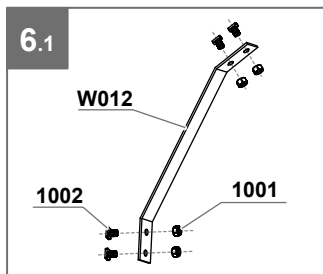
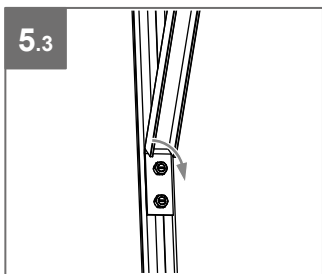
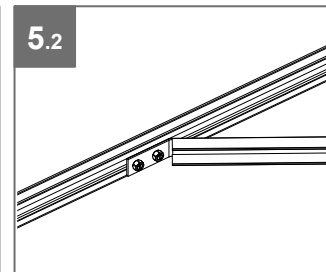
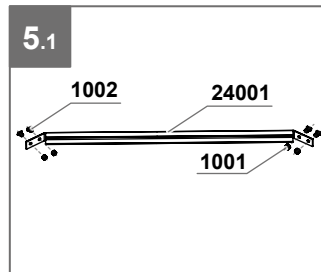
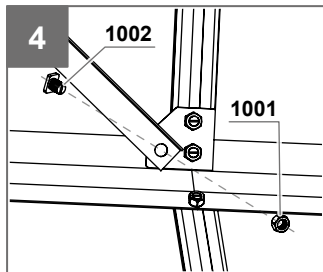
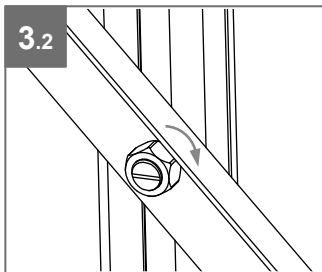
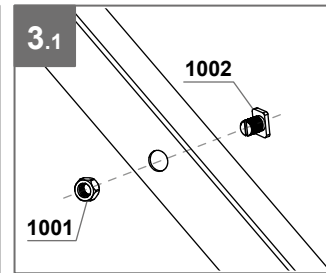
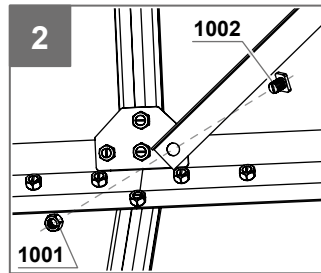
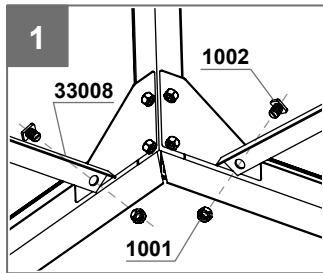

# FIXATION DE LA SERRE SUR LA BASE

## BEFESTIGUNG DES GEWÄCHSHAUSES AM FUNDAMENTRAHMEN

### FASTENING THE GREENHOUSE ONTO THE GREENHOUSE BASE

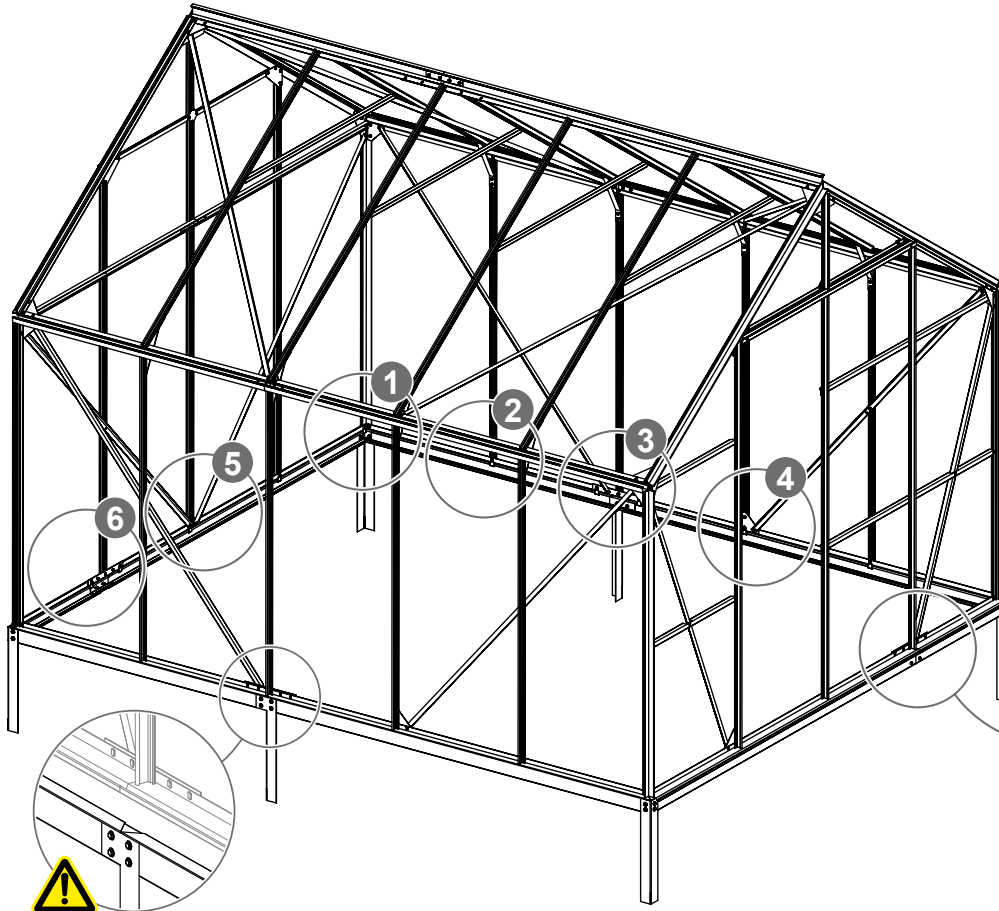

Crochet à positionner  
Haken anbringen  
Attach hook

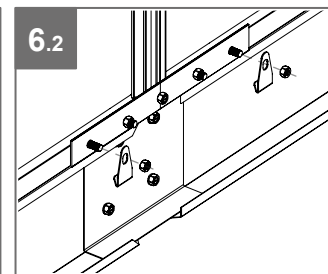
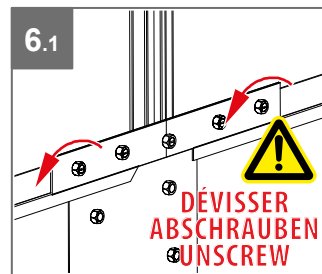
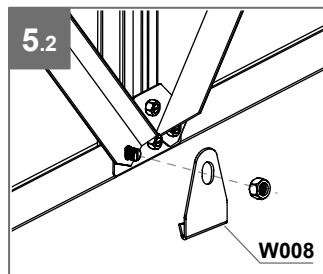
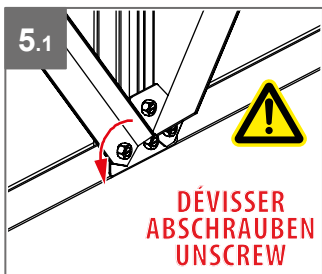
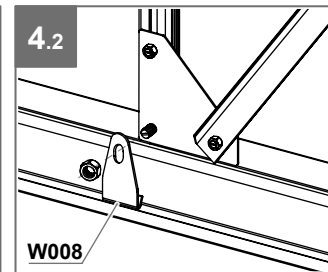
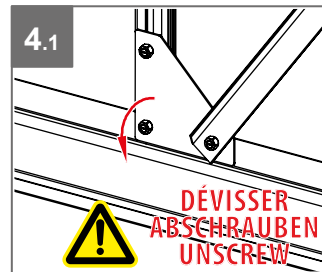
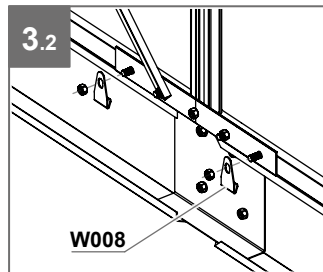
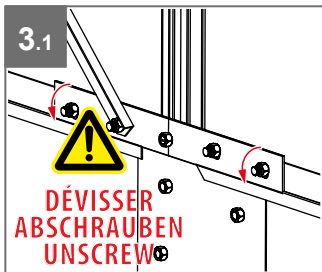
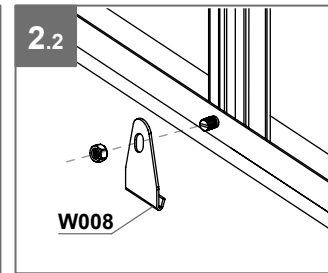
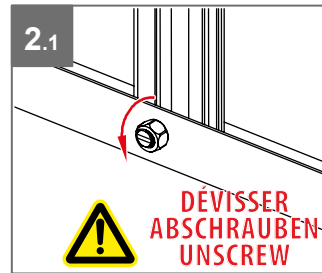
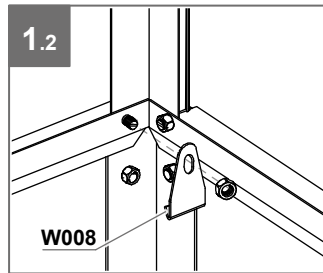
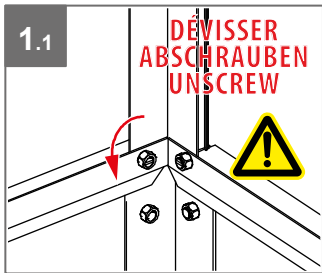
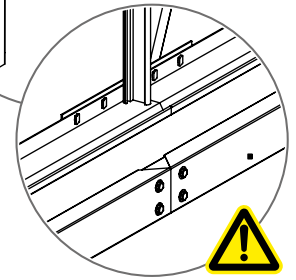
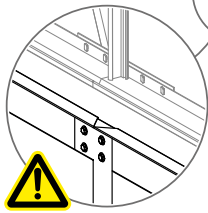

Module de base  
Basismodul  
Basic module

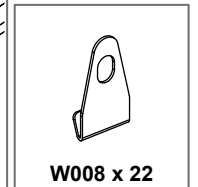

# MONTAGE PORTE + RAIL MONTAGE TÜR + SCHIENE ASSEMBLING DOOR + RAIL



Recommandation : graissage régulier  
Empfehlung : regelmäßig schmieren  
Recommendation : grease regularly



Haut de porte  
Oberer Türbereich  
Upper door area

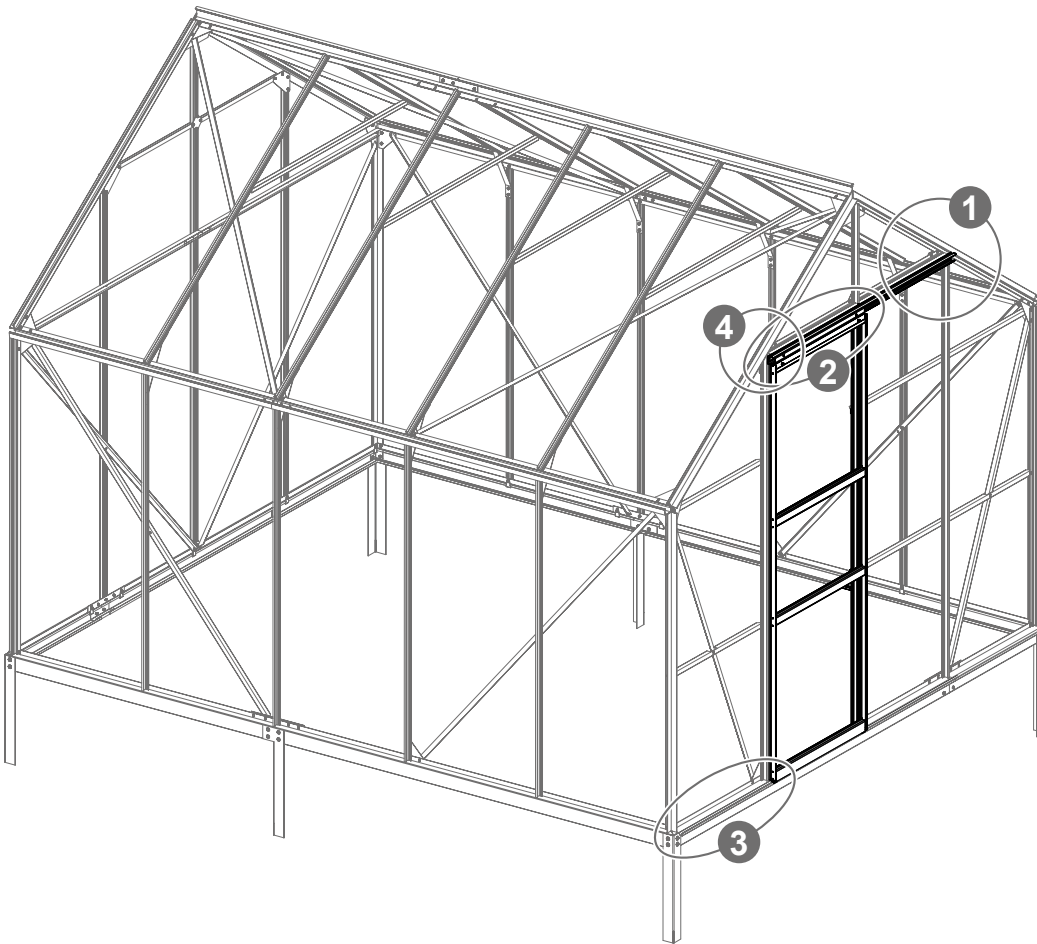

Module de base  
Basismodul  
Basic module

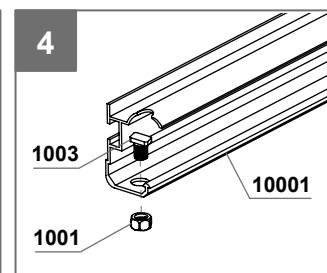
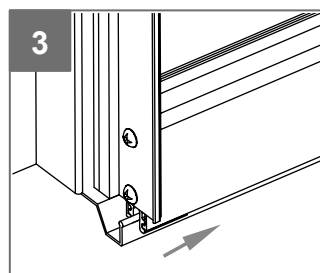
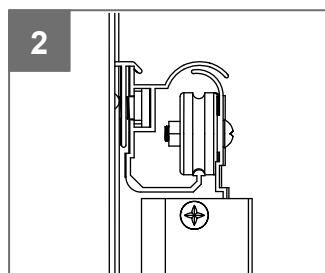
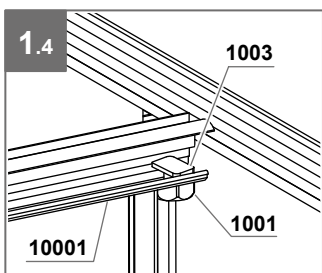
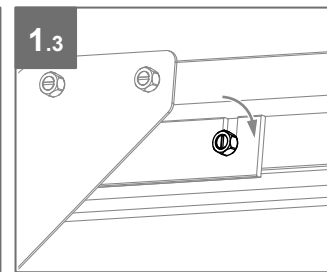
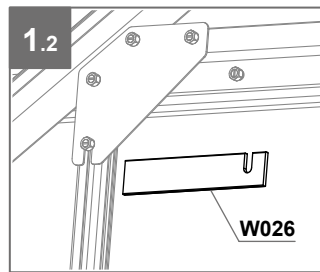
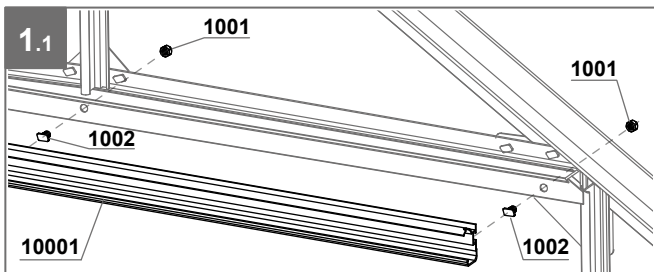
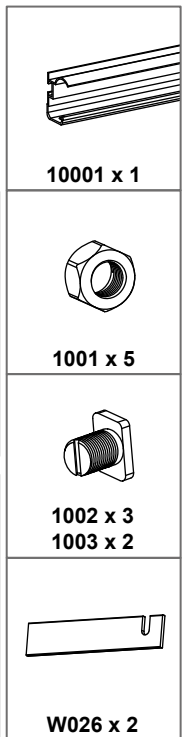

# POSE DU JOINT DE VITRAGE VERGLASUNGSDICHTUNG ANBRINGEN INSTALLING THE GLAZING SEAL

Le joint caoutchouc est à poser sur les profilés de toiture, parois et porte.  
Die Gummidichtung ist auf allen Dach-, Wand- und Türprofile anzubringen.  
The rubber seal is to be attached on all the roof, wall and door profiles.

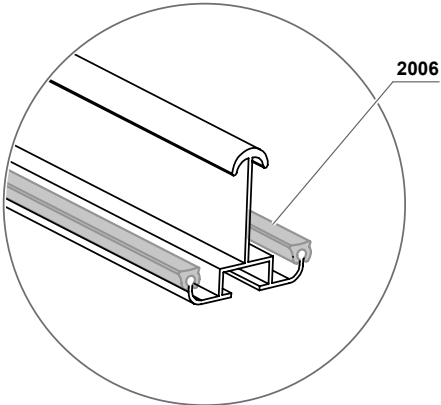

Module de base  
Basismodul  
Basic module

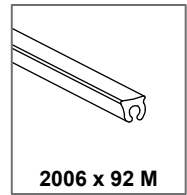

# VITRAGE - VERGLASUNG - GLAZING



Crochets de vitrage  
Verglasungshaken  
Glazing hooks



Clips de vitrage  
Gewächshausklammern  
Glazing clips

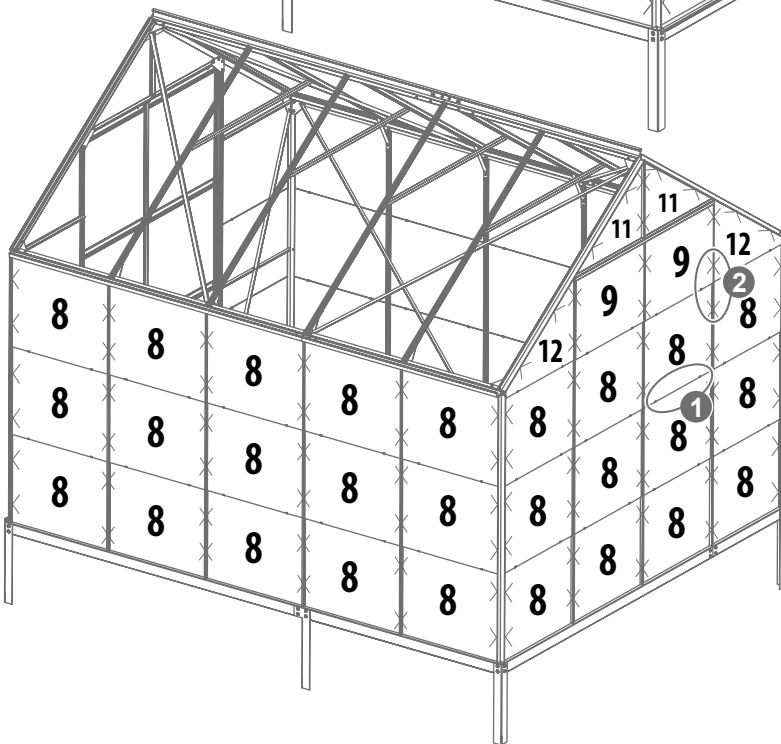
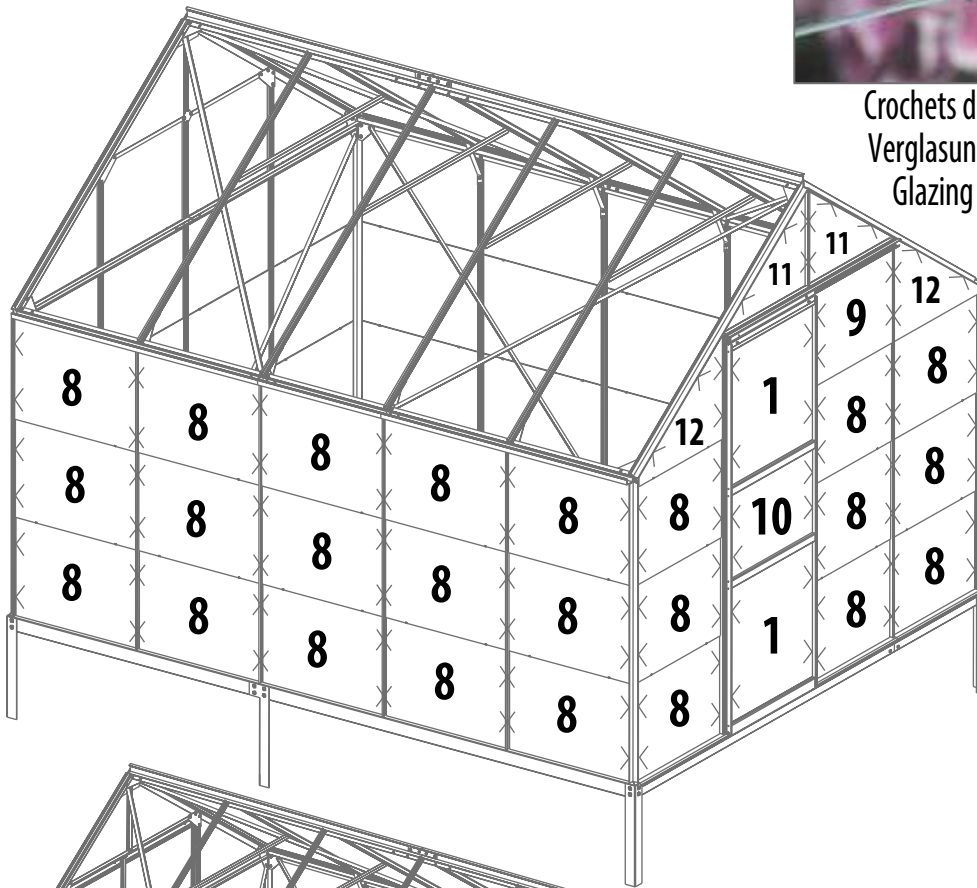

## Module de base Basismodul Basic module

610 x 610  1 x 2
610 x 456  8 x 51
610 x 461  9 x 3
610 x 378  10 x 1
610 x 434/8  11 x 4
610 x 468/44  12 x 4
 W006 x 82
 W007 x 260

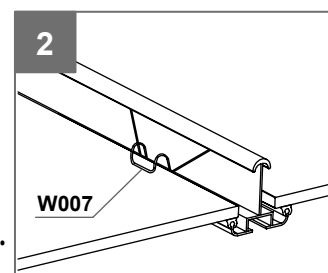
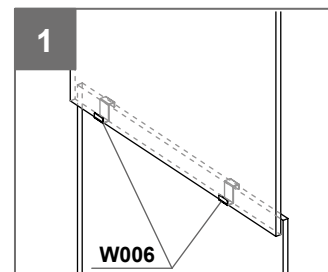

Il peut être nécessaire de dévisser temporairement certains profilés pour la mise en place des verres.

Resserer correctement les vis après la pose des verres.

Zum Anbringen der Gläser kann es erforderlich sein, bestimmte Profile vorübergehend abzuschrauben. Schrauben Sie diese nach der Anbringung der Gläser wieder fest.

Some profiles may need to be temporarily unscrewed to install the glazing. Refix the screws correctly after installing the glazing.

# VITRAGE + POSE LUCARNE

## VERGLASUNG + FENSTER EINBAUEN

### GLAZING + INSTALLING WINDOW



Lucarne - vue extérieure  
 Fenster - Außenansicht  
 Window - exterior view



1  
 Pose de la lucarne sur faîtière  
 par glissement.  
 Anbringung des Fensters auf  
 First durch Gleiten.  
 Installing the window on  
 roof ridge through sliding.

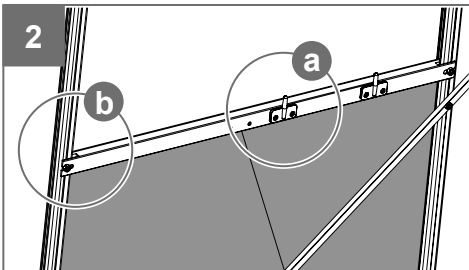
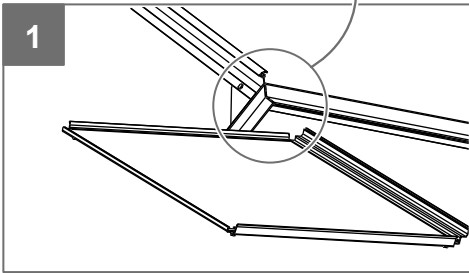
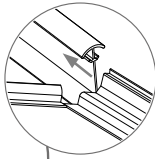

b.1  
 Couper le joint pour  
 passage de la pièce 39001

Dichtung schneiden um Einzelteil 39001 durchzulassen  
 Cut the seal to let part 39001 through

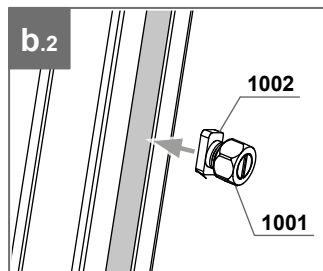

b.2  
 1002  
 1001

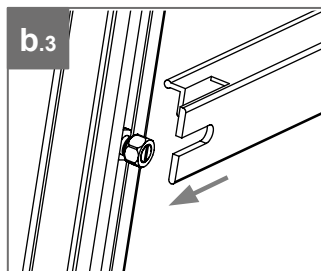

b.3

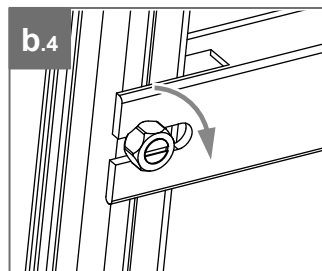

b.4

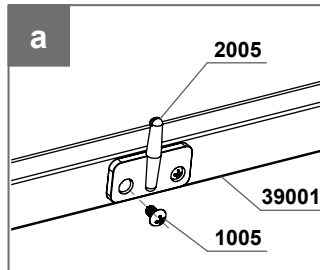

a  
 2005  
 39001  
 1005

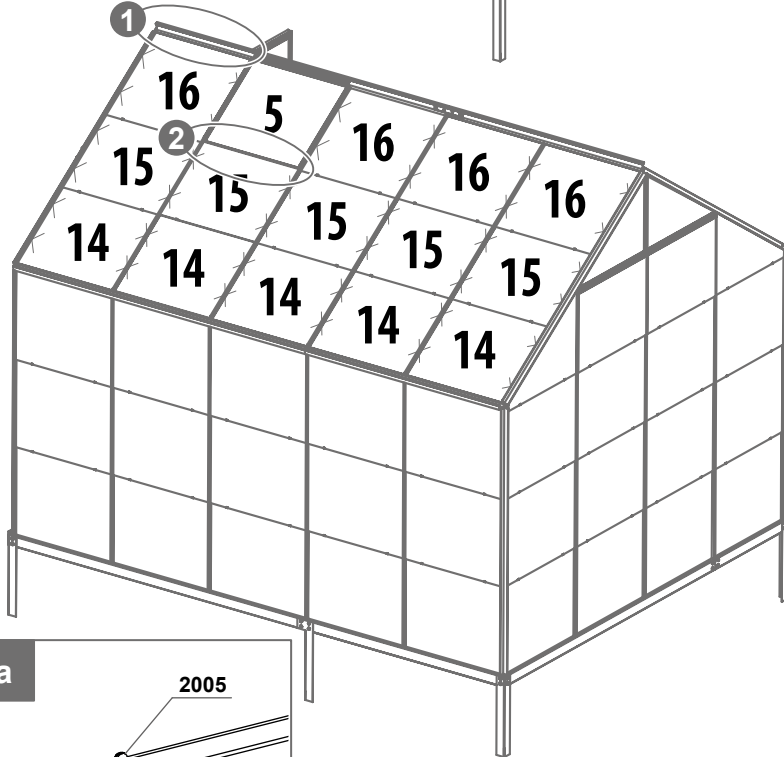
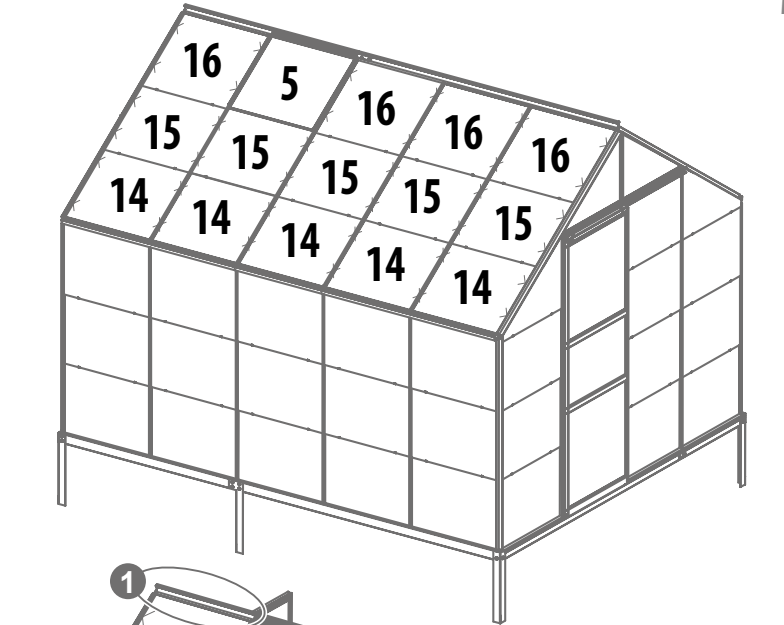

#### Module de base Basismodul Basic module

610 x 509



14 x 10

610 x 487



15 x 10

610 x 549



16 x 8

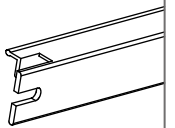

39001 x 2



1001 x 4



1002 x 4



1005 x 8



2005 x 4



W006 x 36



W007 x 112



# MONTAGE DES PIÈCES PLASTIQUES

## MONTAGE DER KUNSTSTOFFTEILE

### INSTALLING THE PLASTIC PARTS



Détail embout de faîtière (pièce 2010)  
 Abdeckung der Firstspitze (Einzelteil 2010)  
 Roof ridge end cover (part 2010)

#### Module de base Basismodul Basic module

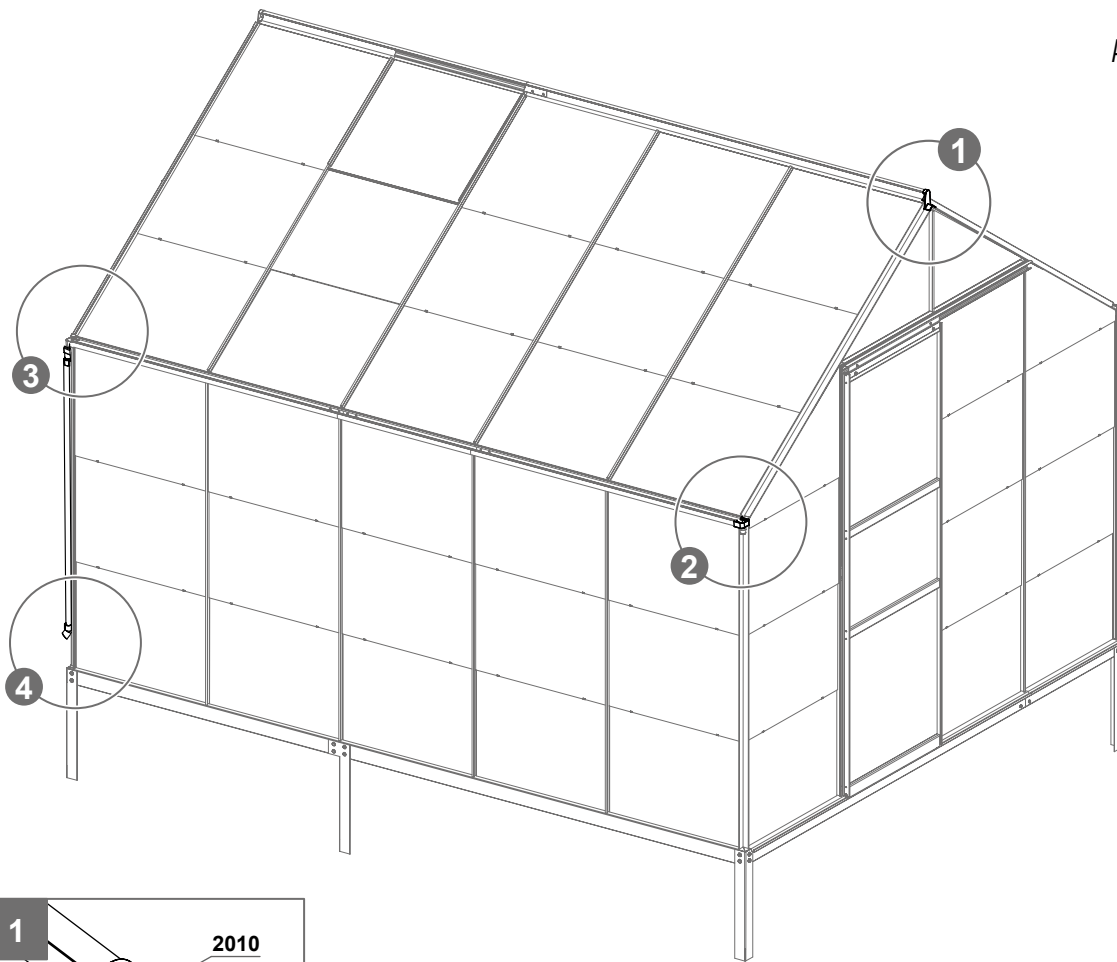

1005 x 4



2010 x 2

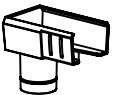

2022 x 2



2023 x 2



2028 x 2



2032 x 2

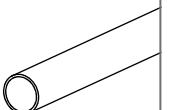

2035 x 2



58001 x 4

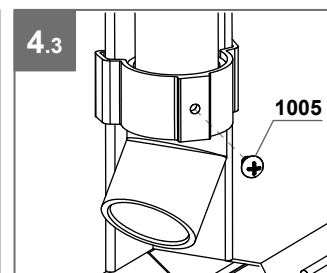
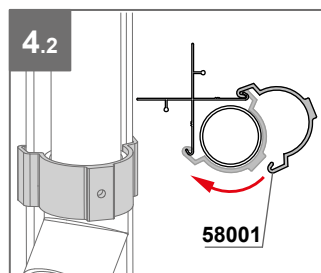
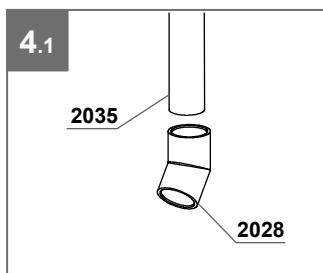
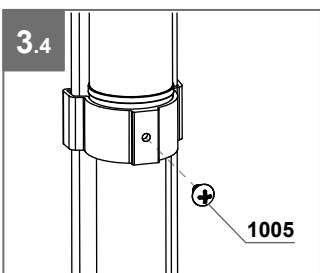
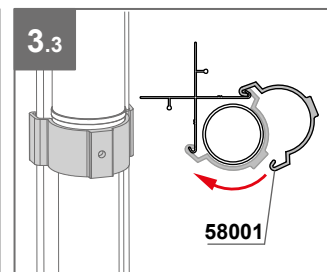
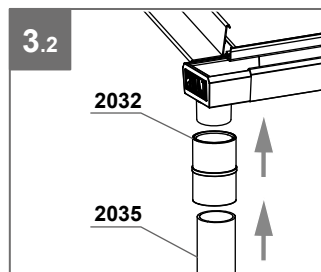
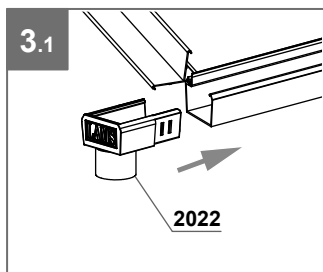
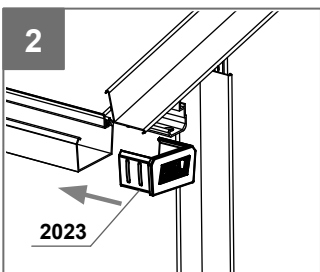
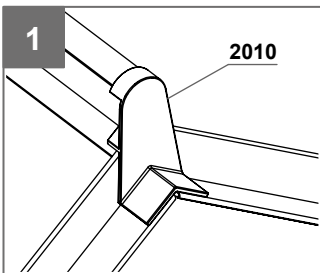

# ACCESSOIRES COMPLÉMENTAIRES DISPONIBLES SUR NOTRE SITE ZUSÄTZLICHES ZUBEHÖR AUF UNSERER WEBSITE VERFÜGBAR ADDITIONAL ACCESSORIES AVAILABLE ON OUR WEBSITE

 [WWW.SERRES-LAMS.COM](http://WWW.SERRES-LAMS.COM)

 [WWW.GEWAECHSHAUS-LAMS.COM](http://WWW.GEWAECHSHAUS-LAMS.COM)

## QUELQUES ACCESSOIRES - EINIGE ACCESSOIRES - SOME ACCESSORIES



**Système d'ombrage**  
Beschattungssystem  
Shading system

*Permet de réguler la température de votre serre.  
Ermöglicht die Temperatur zu regulieren.  
Allows to regulate the temperature of your greenhouse.*



**Kit descente de gouttière**  
Regenfallrohr-Set  
Rain gutter kit

*Permet de récupérer l'eau de pluie.  
Ermöglicht das Auffangen von Regenwasser.  
Allows to collect rainwater.*



**Ouverture automatique de lucarne**  
Automatischer Fensteröffner  
Automatic window opener

*Système d'aération automatique (à partir de 17°C).  
Automatisches Belüftungssystem (ab 17°C).  
Automatic aeration system (from 17°C).*



**Ventouse**  
Saugnapf  
Suction cup

*Facilite le transport et la pose des verres.  
Erleichtert das Tragen und Anbringen der Gläser.  
Facilitates the transport and installation of the glass.*



**Clips de vitrage à ressort**  
Federbelastete Gewächshausklammern  
Spring glazing clips

*Permettent de maintenir le vitrage des serres.  
Halten die Verglasung der Gewächshäuser.  
Maintain the glazing of the greenhouses.*



**Crochets de vitrage**  
Verglasungshaken  
Glazing hooks

*Permettent de faire chevaucher deux vitrages.  
Ermöglicht die Überlappung von zwei Glasscheiben.  
Allows the overlap of two glasses.*





 [WWW.SERRES-LAMS.COM](http://WWW.SERRES-LAMS.COM)

SERVICE CLIENTS

*Site internet : [www.sav-doviris.com](http://www.sav-doviris.com)*

 [WWW.GEWAECHSHAUS-LAMS.COM](http://WWW.GEWAECHSHAUS-LAMS.COM)

KUNDENSERVICE

*[kontakt@gewaechshaus-lams.com](mailto:kontakt@gewaechshaus-lams.com)*